

**Burner Systems:**

G52-18/20-SS  
G52-24/30-SS



**For use with natural gas only**



**DESIGN CERTIFIED to:**  
Manually Lighted, Natural Gas Vented Decorative Appliance  
**ANSI Z21.84**  
Outdoor Decorative Appliance  
**ANSI Z21.97**  
**CSA 2.41**

**FOR INSTALLATION IN SOLID-FUEL BURNING (OR CERTIFIED RHP/AFD) FIREPLACES**  
(Solid-fuels shall not be burned in a fireplace where a decorative appliance is installed.)

**G52 STAINLESS VENTED BURNER FOR INDOOR OR OUTDOOR USE (MANUALLY LIGHTED)**

**WARNING**

If the information in this manual is not followed exactly, a fire or explosion may result, causing property damage, personal injury, or loss of life.

Do not store or use gasoline or other flammable vapors and liquids in the vicinity of this or any other appliance.

A propane cylinder not connected for use shall not be stored in the vicinity of this or any other appliance.

**WHAT TO DO IF YOU SMELL GAS:**

- Shut off gas to the appliance.
- Extinguish any open flame.
- If odor continues, keep away from the appliance and immediately call your gas supplier or fire department.

Installation and service must be performed by a qualified professional service technician, service agency, or the gas supplier.

This appliance is only for use with the type of gas indicated on the rating plate.

**⚠ DANGER**

**CARBON MONOXIDE HAZARD**

This appliance can produce carbon monoxide which has no odor.

Using it in an enclosed space can kill you.

Never use this appliance in an enclosed space such as a camper, tent, or car.



**IMPORTANT: READ THESE INSTRUCTIONS CAREFULLY BEFORE STARTING INSTALLATION OF THE UNIT.**

**⚠ WARNING**

Improper installation, adjustment, alteration, service, or maintenance can cause property damage, personal injury, or loss of life. Read the installation, operating and maintenance instructions thoroughly before installing or servicing this equipment.

The Real Fyre gas log set is to be installed only in a solid-fuel burning (or certified RHP/AFD) fireplace with a working flue and constructed of noncombustible material. The installation, including provisions for combustion and ventilation air must conform with *National Fuel Gas Code, ANSI Z223.1/NFPA 54, or CSA B149.1, Natural Gas and Propane Installation Code*, and applicable local building codes.

A damper clamp is included to maintain the minimum permanent vent opening and to prevent full closure of the damper blade. **The chimney damper MUST be fully opened when burning the unit. Adequate ventilation is absolutely necessary.**

To comply with certification, listings, and building code acceptances, and for safe operation and proper performance of this gas log set, you must use ONLY Peterson parts and accessories. Use of any other controls, parts, or accessories not designed for use with Real Fyre gas log set is prohibited. This will void all warranties, certifications, listings, and building code approvals, and may cause property damage, personal injury, or loss of life. Peterson will not be liable for any damages caused by this misuse.

**INSTALLER:**  
Leave this manual with the appliance.  
**CONSUMER:**  
Retain this manual for future reference.



# TABLE OF CONTENTS

## GETTING STARTED

IMPORTANT PRE-INSTALLATION AND FIREPLACE SAFETY INFORMATION .....	3
FIREPLACE OPERATING SAFETY INFORMATION .....	4
SPECIFICATIONS.....	5
DAMPER CLAMP INSTRUCTIONS .....	6
G52 STAINLESS STEEL BURNER PARTS LIST .....	7

## INSTALLATION

INSTALLATION .....	8
<i>BURNER INSTALLATION</i> .....	8
<i>LAVA GRANULES (DECORATIVE)</i> .....	9
<i>SAND PLACEMENT</i> .....	9
<i>INITIAL GLOWING EMBERS (A) PLACEMENT</i> .....	9
<i>LOG SET, BOOSTER GRID, GLOWING EMBERS (B), AND BRYTE COALS PLACEMENT</i> .....	10

## USE, CARE, & SERVICE

LIGHTING INSTRUCTIONS .....	12
<i>FOR YOUR SAFETY, READ BEFORE LIGHTING</i> .....	12
<i>TO SHUT OFF GAS TO THE APPLIANCE</i> .....	12
CLEANING AND SERVICING.....	13
FLAME DESCRIPTION .....	13
TROUBLESHOOTING.....	14
WARRANTY .....	16

## IMPORTANT PRE-INSTALLATION AND FIREPLACE SAFETY INFORMATION

- CAUTION:** Installation and repair must be done by an NFI Certified or other qualified professional installer.
- Installer:** Carefully read these instructions before installing this gas burner system. Be sure you understand all safety precautions and warnings contained in this manual.
- A. BE CAREFUL:** If not installed, serviced, and used correctly per these instructions, this product can cause serious personal injury, property damage, or loss of life.
- B. WARNING:** When installing in a solid-fuel-burning fireplace, **the chimney flue, damper, and firebox must be thoroughly CLEANED** of soot, creosote, ashes, and loose paint, and must be inspected by a qualified chimney cleaner. Some older fireplaces may need repair prior to installing this appliance.
- C.** This appliance is only for use with the type of gas indicated on the rating plate. This appliance is **NOT FIELD CONVERTIBLE** for use with other gasses.
- CHECK GAS TYPE (natural): The gas supply must be the same as stated on your burner system rating plate. If gas supply is different, **DO NOT INSTALL**. Contact your dealer for immediate assistance.
- D. INSUFFICIENT GAS PRESSURE WILL KEEP THE UNIT FROM OPERATING PROPERLY. DO NOT USE IF GAS PRESSURE IS LOWER THAN THE MINIMUM REQUIREMENT.**
- E.** The minimum inlet gas supply pressure for purposes of input adjustment is **5"** water column (w.c.) on **natural gas**. Insufficient gas pressure will affect proper operation of the pilot (if equipped). Do not install this gas appliance if minimum pressure is not available. The maximum inlet gas supply pressure is 10.5" w.c. on natural gas. (Do not connect this appliance directly to a natural gas tank-this can cause an explosion.)
- F. The gas piping system must be sized to provide minimum inlet pressure at the maximum flow rate (BTU/hr).** Undue pressure loss will occur if the pipe is too small, or the run is too long. Gas supply pipe must be 1/2" minimum interior diameter. If the gas line is longer than 20', a larger diameter line may be necessary. Refer to the NFPA 54 guidelines for further details.
- G.** Input ratings shown in BTU per hour are for elevations up to 2,000 ft. For elevations above 2,000 ft., refer to the National Fuel Gas Code or contact manufacturer before installing this product.
- H.** This gas appliance and its main gas valve must be disconnected from the gas-supply piping system during any pressure testing of that system at test pressures in excess of 1/2 psig.
- I.** This gas appliance must be isolated from the gas-supply piping system by closing the equipment shutoff valve connected to the gas-supply line during any pressure testing of the gas-supply piping system at test pressures equal to or less than 1/2 psig.
- J. To install the gas appliance in your fireplace, the fireplace MUST meet the minimum size requirements (see product specifications table in SPECIFICATIONS section).**
- K.** This appliance may be installed in an aftermarket, permanently located, manufactured (mobile) home, where not prohibited by local codes. Installation of appliances designed for manufactured home (U.S. only) or mobile home installation must conform with the Standard *CAN/CSA Z240 MH, Mobile Housing*, in Canada, or with the *Manufactured Home Construction and Safety Standard, Title 24 CFR, Part 3280*, in the United States, or when such a standard is not applicable, *ANSI/NCSBCS A225.1/NFPA 501A, Manufactured Home Installations Standard*.
- L. DO NOT install this burner system if the fireplace hearth is recessed.** The fireplace floor must be at the same level as or higher than the fireplace front opening. If glass doors are used: the fireplace floor must not be blocked by the door frame; the frame must have openings to allow for fresh air circulation. See the SPECIFICATIONS section for details.

## FIREPLACE OPERATING SAFETY INFORMATION

- A. Adults shall be present when this gas appliance is operating. This unit shall not be left burning when unattended or while anyone is sleeping.
- B. Keep the area of the gas burner system clear and free from combustible materials, gasoline, and other flammable vapors and liquids.
- C. Children **MUST** be supervised when they are in the area of this appliance.
- D. **DO NOT** place any part of the body, clothing, or other flammable materials on or near the appliance. Children and adults should be alerted to the hazard of high surface temperatures and should stay away to avoid burns or clothing ignition. **DO NOT** lean over the unit when lighting or when in use.
- E. **DO NOT** use this appliance if any part has been underwater. Immediately call a qualified service technician to inspect the appliance and to replace any part of the control system and any gas control that has been underwater. Attempted operation may result in fire or explosion resulting in property damage, personal injury or loss of life.
- F. **A fireplace screen must be in place when the system is burning.** Provisions for adequate combustion air must be maintained. Unless other provisions for combustion air are provided, the screen shall have an opening(s) for introduction of combustion air. Combustion air is adequate when all flames curl into the fireplace and away from the screen. **When a glass fireplace enclosure (door) is used, leave the doors fully open when the system is in operation.**
- G. Do not remove the rating plates or the warning tags. These are an integral safety and identification component of this appliance.
- H. Be sure to read the CLEANING AND SERVICING and FLAME DESCRIPTION sections.

# SPECIFICATIONS

Real Fyre gas burner systems must be installed only in an approved fireplace with the minimum firebox dimensions and venting requirements met (see following tables). Adequate ventilation is absolutely necessary.

## Product Specifications

Model	Minimum Fireplace Size			BTU Rating	
	Width*		Depth ‡	Height	Nat. Gas
	Front	Rear †			
G52-18/20 (18" log set)	28"	20"	15"	17"	46k
G52-24/30 (24" log set)	32"	24"	15"	17"	55k
G52-24/30 (30" log set)	34"	28"	15"	17"	55k

\* These required widths allow for centering of the unit.  
 † Rear width is at corresponding depth.  
 ‡ If an ash lip exists, the depth requirement begins inside of the lip (see Fig. 5-1 below).

**Table 1** - Product Specifications

## Fireplace Floor Requirement

**DO NOT** install this burner system if the fireplace hearth is recessed. The fireplace floor must be at the same level as or higher than the fireplace front opening. An ash lip or recess may not exceed  $\frac{3}{4}$ ". See Fig. 5-1 below.

**Note:** If glass doors are used: the fireplace floor must not be blocked by the door frame; the frame must have openings to allow for fresh air circulation.

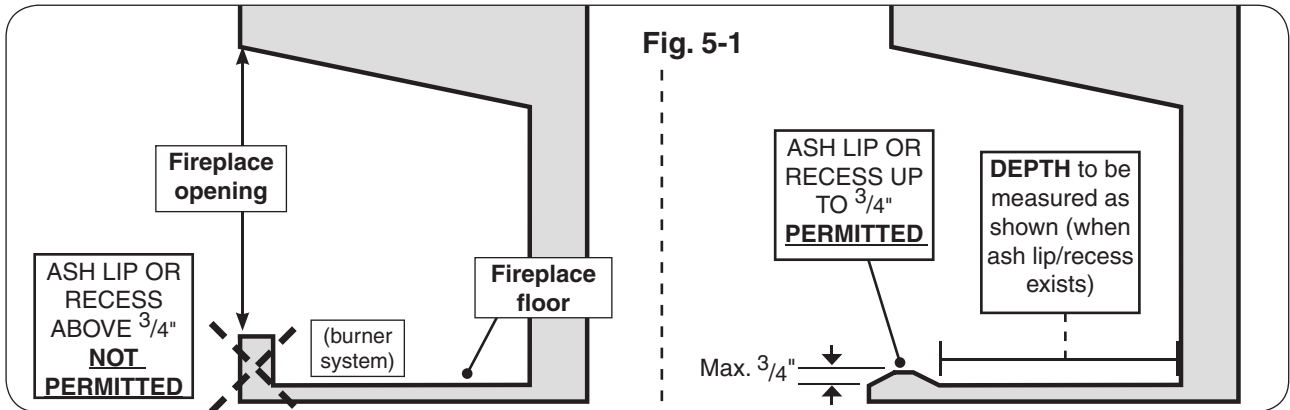

# DAMPER CLAMP INSTRUCTIONS

The damper clamp with hex bolt (Fig. 6-1) is provided as a means to prevent full closure of the damper blade. The clamp is easily attached to most damper blades with pliers or a wrench, and must be permanently installed. The clamp is designed to prevent accidental closure of the damper when installed as illustrated (Fig. 6-2). Should the clamp not fit, or fail to provide the permanent vent opening listed in Table 3 below, have a permanent stop installed, remove the damper blade, or have the damper cut to provide the minimum permanent opening required.

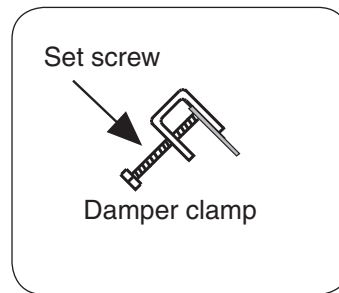

**Fig. 6-1** Damper clamp detail

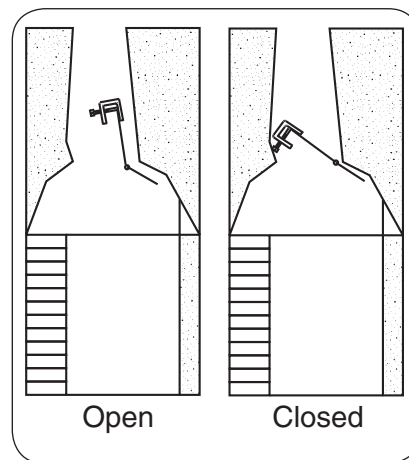

**Fig. 6-2** Damper open / closed

## Venting Requirements

Minimum permanent free opening area of chimney damper for venting (sq. in.)		
For factory-built fireplaces		
Chimney height	18/20"	24/30"
15'	21	24
20'	18	21
30'	14	16
For masonry-built fireplaces		
15'	30	35
20'	27	32
30'	25	29

**Table 2** - Minimum Chimney Damper Vent Opening Requirements

**Note:** For indoor installations, the minimum chimney height from hearth to top of chimney is 15'.

**THESE ARE MINIMUM DAMPER OPENING SPECIFICATIONS.**

**THE DAMPER MUST BE COMPLETELY OPENED WHEN OPERATING THIS GAS APPLIANCE TO ACHIEVE THE BEST VENTILATION POSSIBLE.**

# G52 STAINLESS STEEL BURNER PARTS LIST

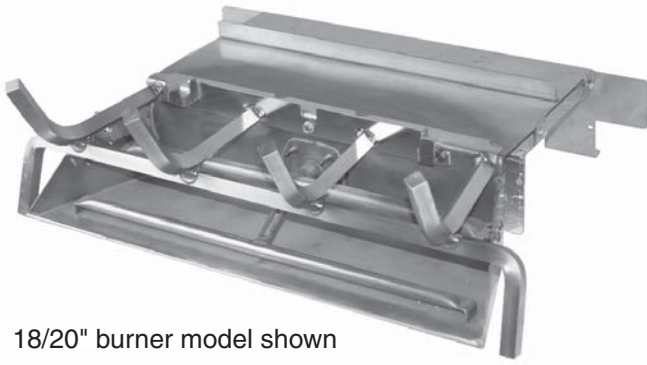

18/20" burner model shown

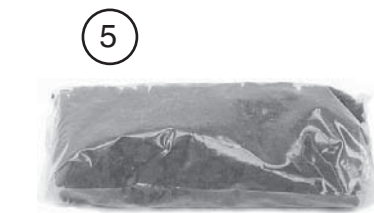
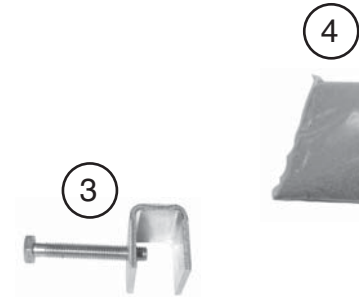
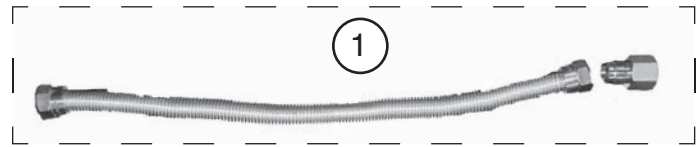
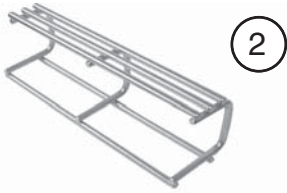
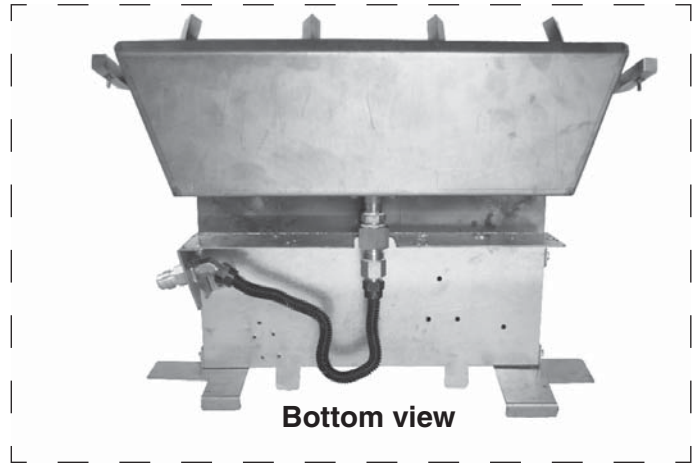

**Note: Photos not to scale**

Replacement parts can be ordered from your local Real Fyre dealer.

The log set is purchased and packaged separately; contact your local Real Fyre dealer when ordering. Refer to the instructions included with the log set.



Item	Description	18/20" model		24/30" model	
		Part No.	Qty.	Part No.	Qty.
1.	Flex connector (w/ adapter), 1/2" O.D. x 18"	CK-41	1	CK-41	1
2.	Radiant booster grid	SC-10	1	SC-15	1
3.	Damper clamp	DC-1	1	DC-1	1
4.	Sand, #16	400071-8	1	400071-10	1
5.	Lava granules	LF-4	1	LF-4	1
6.	Glowing embers A	EM-22A	1	EM-21A	1
7.	Glowing embers B	EM-22B	1	EM-21B	1
8.	Bryte coals	EM-11	1	EM-11	1

# INSTALLATION

The Real Fyre burner system must be installed by a qualified professional service technician. Instructions must be followed carefully to ensure proper performance and full benefit from the burner system. **Check to be sure the burner system is designed and labeled for the type of gas (natural gas only) supplied to the fireplace.** Fireplace floor must be level, clean, and smooth (see FIREPLACE SAFETY INFORMATION section).

**WARNING:** Failure to position the parts in accordance with these diagrams or failure to use only parts specifically approved with this appliance may result in property damage or personal injury.

REFER TO THE PARTS LIST WHEN FOLLOWING INSTALLATION INSTRUCTIONS.

18/20" burner model shown here.

## BURNER INSTALLATION

1. MAKE SURE THE FIREPLACE GAS SUPPLY IS TURNED OFF.
2. Locate the gas-supply stub inside the fireplace and remove the cap, if attached (reference Fig. 8-2).

**CAUTION:** When removing the cap, make sure the stub does not turn, loosening the connection inside the wall.

3. Attach the nut end of the flex connector to the adapter found on the bottom of the burner pan. Tighten securely (See Fig. 8-1).
4. Place the burner system in the fireplace. Center the burner from left to right in the fireplace. (Reference Fig. 8-3 for orientation.)

**Note:** The tabs located on the burner are for spacing and air circulation. See Fig. 8-1.

5. **Be sure gas to the fireplace is off.** Remove the adapter connected to the flex connector. Attach the adapter to the gas-supply stub using a pipe compound resistant to all gasses. Tighten securely. Then attach the flex connector to the adapter. Tighten securely (See Fig. 8-2).
6. **LEAK TEST:** Use a long-necked butane lighter, or lay a lighted match next to the burner pipe, and carefully turn on the gas supply until the burner ignites. Test at all connections for leaks using the appropriate soapy water solution. If bubbles appear, a leak is present. Turn off the gas and tighten at all connections. Repeat until no leaks are present. If a leak persists, turn off the gas supply and contact the local gas company or dealer. **NEVER USE A FLAME TO CHECK FOR LEAKS.**

**Turn off the gas supply and allow unit to completely cool prior to proceeding.**

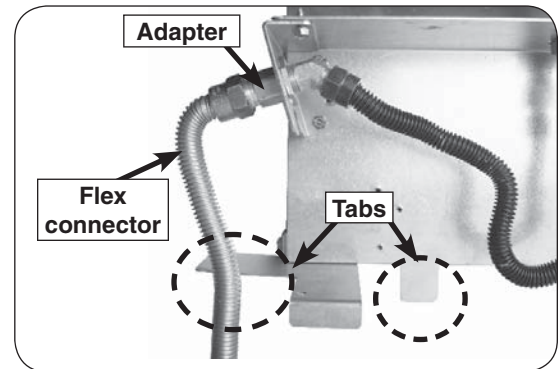

Fig. 8-1 Connect flex to burner

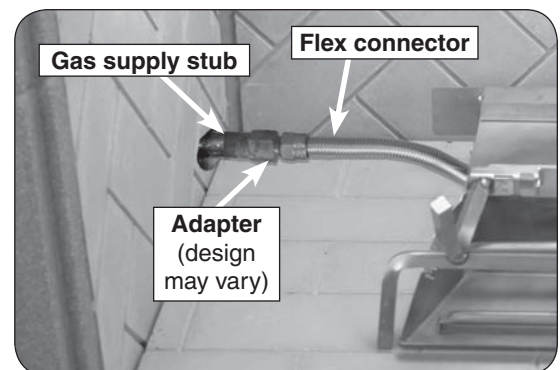

Fig. 8-2 Connect flex to gas supply

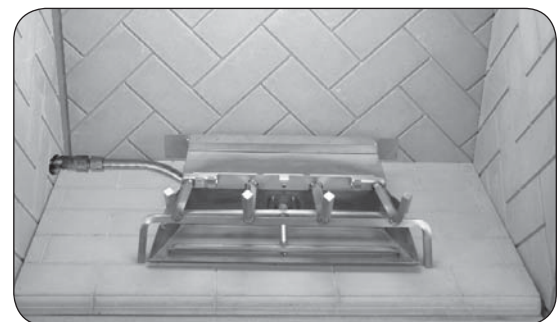

Fig. 8-3 Orientation



## LAVA GRANULES (DECORATIVE)

1. Spread the supplied lava granules on the floor of the fireplace, around the front and sides of the burner system (see Fig. 9-1).

**Note:** DO NOT place any lava granules on the burner system, below it, or behind it.

## SAND PLACEMENT

The sand supplied with the unit is specially selected for use with natural gas. It maximizes flame distribution and provides a cleaner burning flame.

**CAUTION:** Use only the sand provided for this natural gas burner.

1. Fill the burner pan completely with the sand (see Fig. 9-2).
2. **Slope the sand at the same angle as the burner pan and pack tightly.** This is important to ensure quiet lighting and even flame distribution. See Fig. 9-3.

## INITIAL GLOWING EMBERS (A) PLACEMENT

**Important:** The supplied embers are to be applied at several stages of installation. You may end up with some unused embers at the end of installation. If so, store them for later use/replacement.

Sprinkle a portion of the **glowing embers A** lightly and evenly over the entire surface of the sand as shown in Fig. 9-4. **Break up any clumps that may have developed during shipment. Store unused embers for later use/replacement.**

**Important:** Place the **glowing embers A** lightly and evenly as shown. **DO NOT** over apply.



Fig. 9-1 Place lava granules

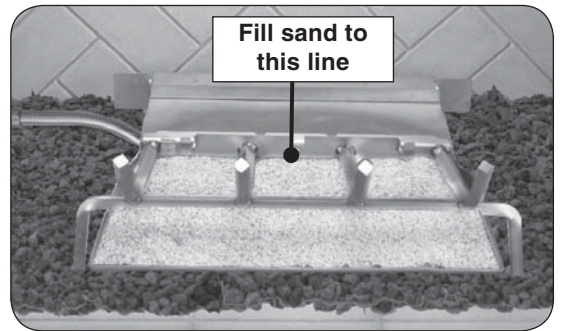

Fig. 9-2 Place sand

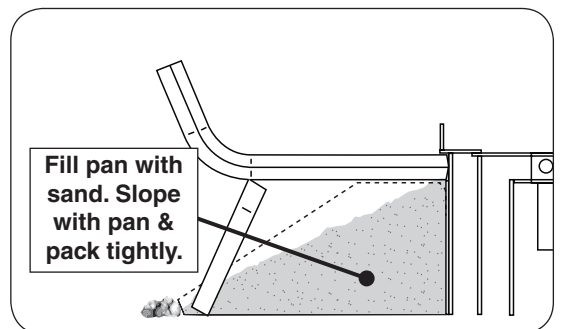

Fig. 9-3 Sand detail

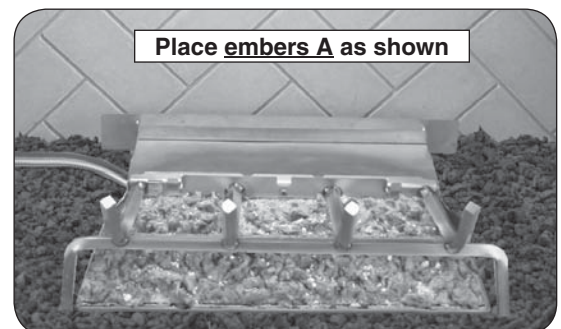

Fig. 9-4 Place glowing embers A

### IMPORTANT

**EMBER PLACEMENT IS NOT COMPLETE AT THIS STAGE.**

**REFER TO THE NEXT PAGE AND THE SEPARATE INSTRUCTIONS PACKED WITH YOUR LOG SET TO CONTINUE INSTALLATION.**

## INSTALLATION (cont.)

### LOG SET, BOOSTER GRID, GLOWING EMBERS (B), AND BRYTE COALS PLACEMENT

- Read all safety warnings and important information in this manual and the instructions supplied with the log set to ensure proper placement.
- **DO NOT** add any additional embers to this setup. Any additional embers will cause unsafe operation.
- Your log set design may slightly vary from the images shown here, but initial placement is the same.

All models begin with the bottom log and ember placement shown below. To complete log placement continue to the instructions supplied with your specific log set.

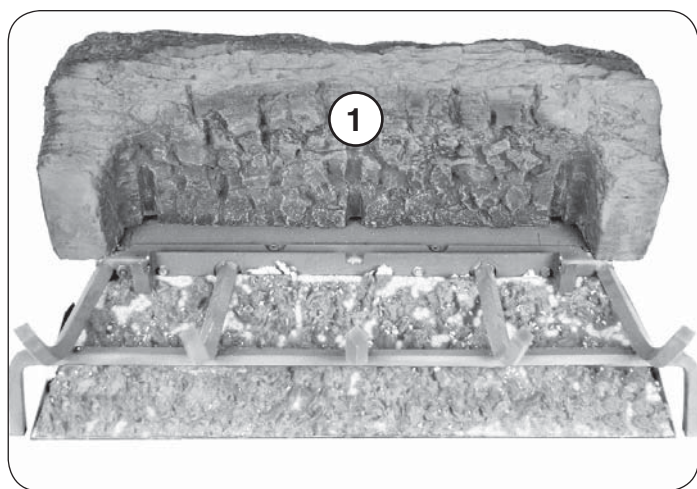

Place the rear log (log #1) as shown. The log should be slid back on the burner until it hits the backstop.

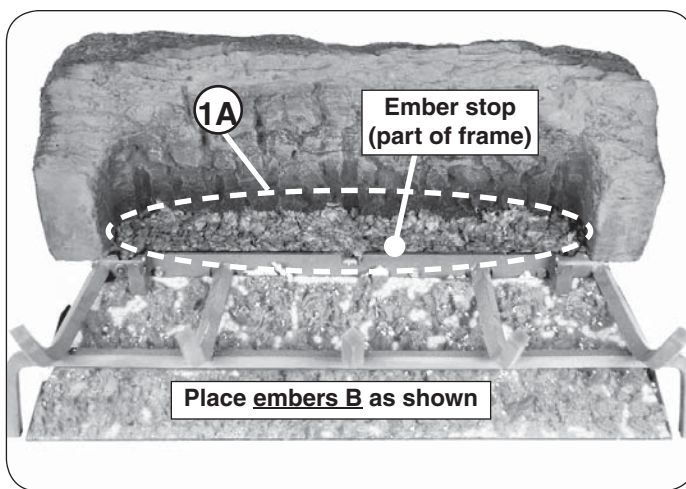

The ember stop at the front of the shelf serves to confine the embers B in place. Place and pack a level amount of **embers B** on the shelf in front of the rear log as shown.

- **PACK THE EMBERS DOWN** (to reduce heat transfer to components below).
- Save a small amount of embers for placement on the radiant booster grid.

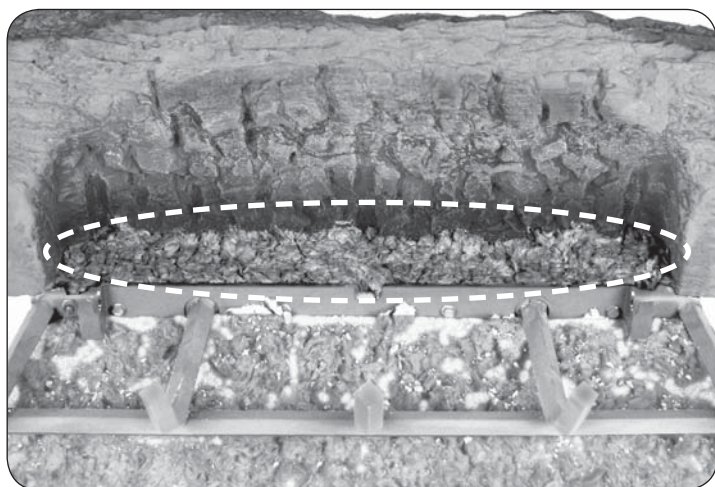

Ensure the embers are level and packed in place.

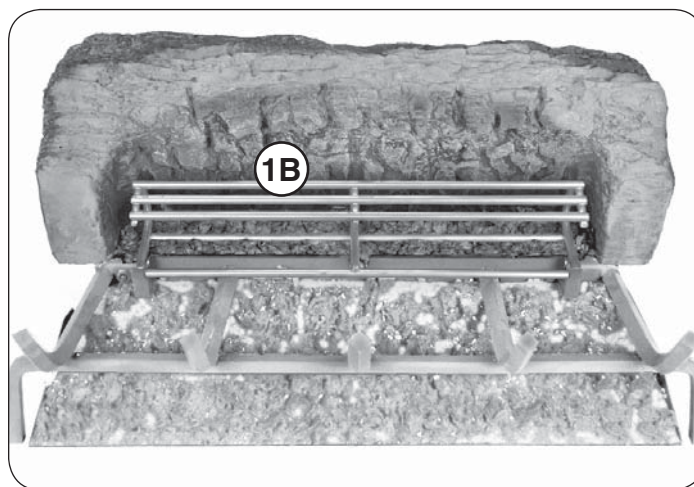

Place the radiant booster grid as shown above and in the next image. The grid should rest against the rear log. The ember stop has notches to properly align the grid in place.

## INSTALLATION (cont.)

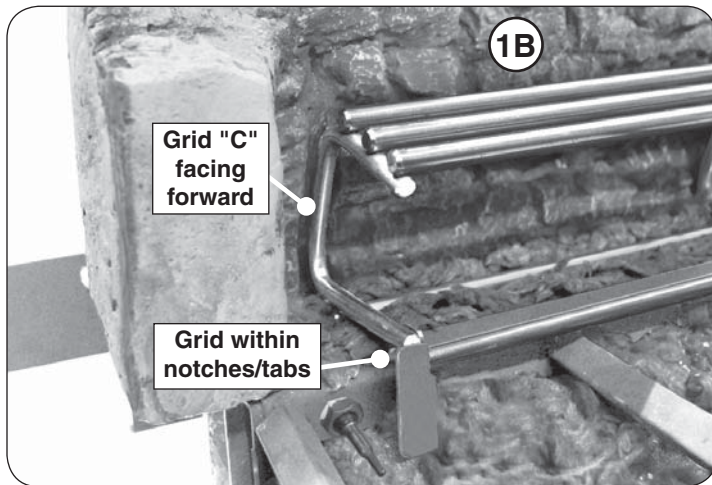

Radiant booster grid detail:

- Rest against rear log, orient with grid "C" facing forward, and within notches/tabs.

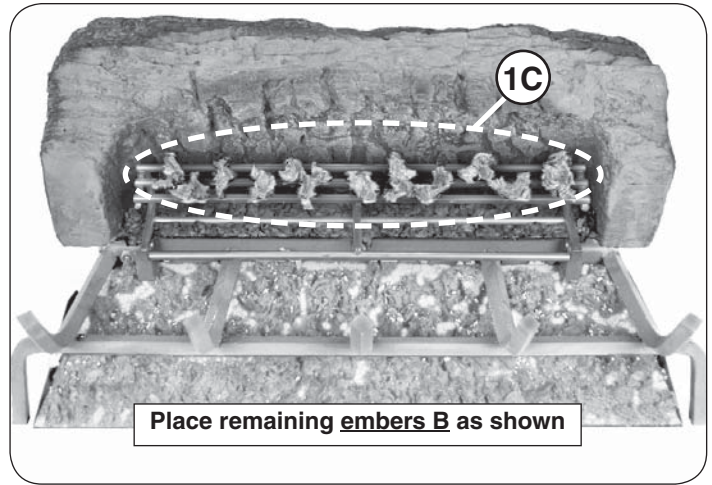

Place the remaining amount of **embers B** across the grid as shown.

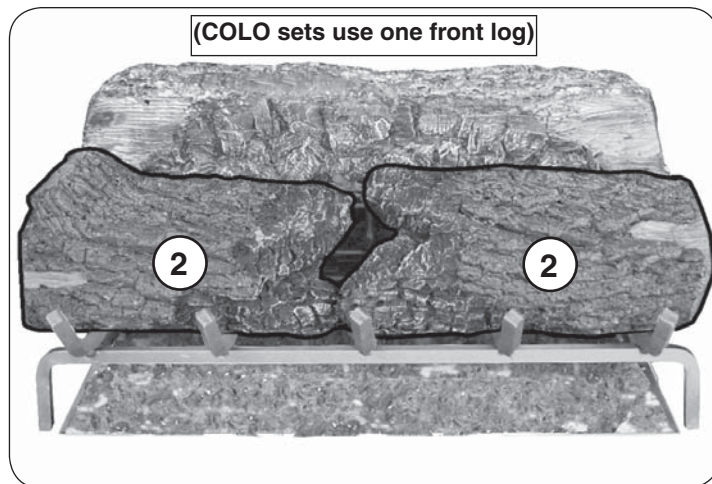

Place the left and right front log pieces (log #2) as shown. The two logs should be touching and centered on the burner from left to right.

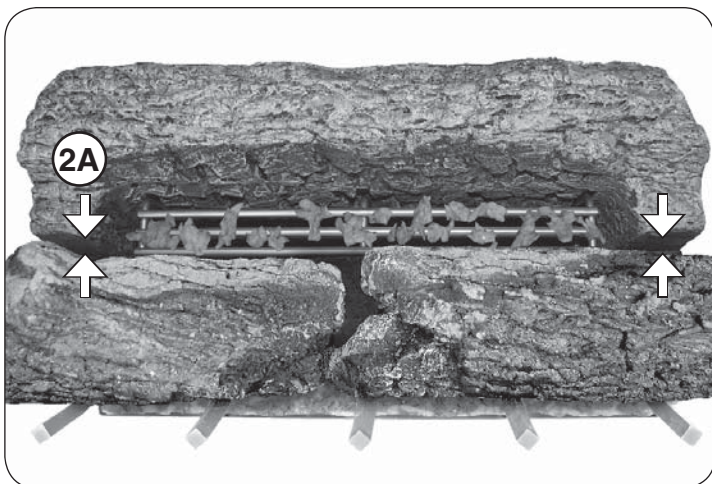

Gently bring together the rear and front logs to create a tight fit around the grid.

**FOLLOW THE INSTRUCTIONS INCLUDED WITH YOUR SPECIFIC LOG SET TO COMPLETE LOG AND BRYTE COALS PLACEMENT.**

**Important:** Adequate ventilation is absolutely necessary! Adequate spacing between the logs is **NECESSARY** and **MUST** be maintained. Provided significant, noticeable sooting **does not** occur, some flexibility is possible in top log placement to suit your individual preference. If you experience a continued accumulation of black carbon (soot) on your logs it is an indication of incomplete combustion and you should move the effected log(s) so as to minimize the flame contact on the effected log(s). If significant sooting continues, stop using this gas log set. Read the instructions supplied with the log set completely and carefully.

**CAUTION:** **BURN HAZARD!** Logs will remain hot for some time after use. If you need to reposition any log to maintain the proper layout, use heat-resistant gloves or allow logs adequate time to cool before handling.

# LIGHTING INSTRUCTIONS

## FOR YOUR SAFETY, READ BEFORE LIGHTING

**WARNING: IF YOU DO NOT FOLLOW THESE INSTRUCTIONS EXACTLY, A FIRE OR EXPLOSION MAY RESULT, CAUSING PROPERTY DAMAGE, PERSONAL INJURY, OR LOSS OF LIFE.**

- A. BEFORE LIGHTING**, smell all around the unit area for gas. Be sure to smell next to the floor, because some gas is heavier than air and will settle on the floor.
- B. WHAT TO DO IF YOU SMELL GAS**
1. Shut off the gas to the appliance.
  2. Extinguish any open flame.
  3. If odor continues, immediately call your gas supplier or the fire department.
- C.** Use only a proper key to turn the gas line valve. Never use tools. If the valve will not turn, **DO NOT** try to repair it. Call a qualified professional service technician. Force or attempted repair may result in fire or explosion.

1. **STOP!** Read the safety information above.
2. Ensure the key valve is completely in the **OFF** position before beginning lighting sequence.
3. Lay a lighted match on the center of the top burner (**do not hold the match in your hand**) or use a lighted long-stem match/long-necked butane lighter (Fig. 12-1).
4. **Once the match is burning and in position**, slowly turn the key valve counter-clockwise toward the **ON** position until it no longer rotates (see Fig. 12-2). Your burner should light.

**WARNING:** If the burner does not light within (5) seconds of turning on the key valve, immediately turn the key valve clockwise toward the **OFF** position until it no longer rotates.

Wait approximately five (5) minutes to clear out any gas, and repeat steps 3-4 above.

**If your burner fails to light again, turn the key valve clockwise toward the OFF position until it no longer rotates and contact your dealer or gas supplier.**

**Note:** The flame height can be adjusted via the key valve.

### TO SHUT OFF GAS TO THE APPLIANCE

**To extinguish your gas burner**, turn the key valve clockwise toward the **OFF** position until it no longer rotates (see Fig. 12-2). Be sure the key valve is turned fully off to avoid any gas leakage.

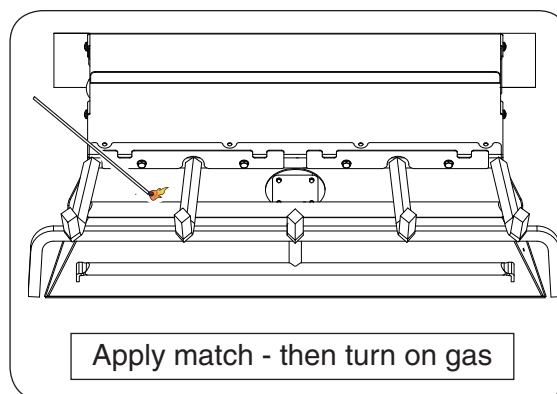

**Fig. 12-1**

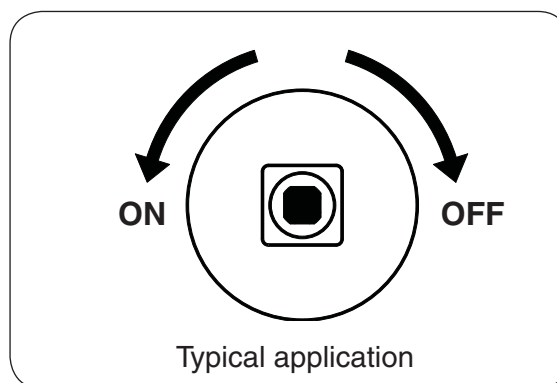

**Fig. 12-2**

## CLEANING AND SERVICING

**Note:** Servicing may be necessary to ensure proper operation and burn characteristics.

Always shut off the gas to the appliance while performing service work.

Allow the appliance to cool before servicing.

**Installation, service, and repair must be done by an NFI Certified or other qualified professional service technician. The appliance should be examined before use, and must be inspected at least annually to prevent burner shutdown, sooting, odors, etc. It must be checked for clean burning operation with the correct tools to service this unit. More frequent servicing may be required.** It is imperative that all components and compartments, burner(s), and circulating air passageways of the appliance be kept clean and free of all obstructions (as applicable).

The burner assembly must be replaced prior to the unit being put into operation if it is evident that the burner is damaged. Contact your local dealer for replacement parts.

**DO NOT** use substitute materials when replacing any components of the appliance.

In addition, a periodic examination and cleaning of the fireplace venting system should be conducted by a qualified professional service technician.

**Any safety screen or guard removed for servicing must be replaced prior to operating this appliance.**

Verify proper operation after servicing.

If, after a period of use, the flames start to exhibit unusual shapes and behavior, or the burners fail to ignite smoothly, the burner may require cleaning or servicing. If this happens, it is recommended to contact the nearest dealer to get the appliance serviced.

**DO NOT** remove the rating plates or the warning tags. These are an integral safety and identification component of this appliance.

**We recommend following these instructions at the beginning of each fireplace season and as needed throughout the year, depending on your usage pattern and the environmental conditions in your home.**

## FLAME DESCRIPTION

Observe the flames. The main burner flames should be blue at the base and a combination of blue/yellow at the body and at the tips. They should be approximately 5-8" above the logs, with the center flame being the tallest. The ember flames should be 1/4" to 5" above the embers. (See 13-1 for example.)



**Fig. 13-1** Flame appearance

## TROUBLESHOOTING

POSSIBLE CAUSE	SOLUTIONS
<b>1 BURNER SHUTTING DOWN DURING OPERATION</b>	
<b>A.</b> Insufficient or excessive gas pressure	<b>A1.</b> Check gas pressure (Read D.- F. of IMPORTANT PRE-INSTALLATION AND FIREPLACE SAFETY INFORMATION section, & <u>check with local gas company</u> ). <b>A2.</b> Other gas appliances may be on the same gas line, dropping gas pressure to the burner. Check pressures with everything operating to ensure adequate pressure.
<b>B.</b> Fireplace too small for unit	<b>B.</b> Ensure minimum requirements are met (see SPECIFICATIONS section).
<b>C.</b> Blockages on burner	<b>C.</b> Vacuum any lava granules or material that may have fallen onto burner port area.
<b>D.</b> Unit exposed to high-wind conditions	<b>D.</b> Ensure that the unit is installed in an area that is less susceptible to high wind conditions. <b>DO NOT operate in high-wind conditions.</b>
<b>2 LOW FLAME HEIGHT</b>	
<b>A.</b> Gas pressure	<b>A.</b> Check gas pressure (see Section 1, A1 of this table).
<b>B.</b> Key valve not fully open	<b>B.</b> Open key valve fully.
<b>C.</b> Blockage or kink in flex connector kit, plumbing, or burner orifice	<b>C.</b> Clean out blockage. If flex connector is kinked, replace it.
<b>3 BURNER NOT BURNING EVENLY</b>	
<b>A.</b> Burner ports clogged	<b>A.</b> Clean burner ports.
<b>B.</b> Media may be packed down too tightly	<b>B.</b> Loosen media around burner pipe by running a flathead screwdriver along both sides of the pipe. Even out media in burner pan.
<b>C.</b> Top burner lights; bottom burner has delayed ignition.	<b>C.</b> Check gas pressure. Can be caused by too small of a gas line (see Section 1, A1 of this table).
<b>4 ODORS</b>	
<b>A.</b> Gas leak	<b>A.</b> Shut off gas, if possible. Follow instructions on front page. Have a qualified professional installer or the gas company correct all leaks.
<b>B.</b> New home, new carpet, or new paint	<b>B.</b> When these odors are drawn into the fireplace, this may cause objectionable odors. Thoroughly ventilate the area before restarting your burner system.
<b>C.</b> Damper closed	<b>C.</b> Ensure that damper is open.
<b>5 FLAME LIFTS OFF THE BURNER ASSEMBLY</b>	
<b>A.</b> Unit exposed to high-wind conditions	<b>A.</b> Ensure that the unit is installed in an area that is less susceptible to high wind conditions. <b>DO NOT operate in high-wind conditions.</b>

<b>A.</b> Poor draft or downdraft	<b>A.</b> Check for chimney blockage. Be sure chimney is at least 3' taller than anything within 10' of it in all directions. If not, consult a chimney sweep. A chimney cap or fan may help.
<b>B.</b> Damper closed	<b>B.</b> Ensure that damper is open.
<b>C.</b> Burner is positioned too close to the front of the firebox	<b>C.</b> Move burner system to the center of the firebox.
<b>D.</b> Improper media placement	<b>D.</b> See INSTALLATION section for proper media placement.
<b>E.</b> Air shutters blocked (if applicable)	<b>E.</b> Air shutters are blocked with debris. Vacuum debris away from air shutter.
<b>F.</b> Log placement	<b>F.</b> See solution in Section 1, B.
<b>G.</b> Using natural-gas burner on propane gas	<b>G.</b> If the gas listed on the nameplate does not match the gas you are burning, shut down the burner system immediately. Then call your dealer.
<b>H.</b> Adding any accessories to burner system	<b>H.</b> Shut down burner system and take off any accessories that do not belong with the system.

# WARRANTY

## PETERSON OUTDOOR VENTED DECORATIVE GAS APPLIANCE LIMITED WARRANTY

Robert H. Peterson Co. ("RHP") warrants your Real Fyre® vented decorative gas appliance to be free from defects in material and workmanship.

Peterson vented ceramic refractory gas logs are warranted for **THREE (3) years when used outdoors and as long as you own them (lifetime) when used indoors.**

Peterson vented stainless steel fireplace burner assemblies excluding valves, pilots, and controls are **WARRANTED for FIVE (5) YEARS.**

Peterson glass, gems, nuggets, and fiber-ceramic blend gas logs are warranted for **FIVE (5) YEARS.**

All Peterson valves, pilots, and controls are warranted for **ONE (1) YEAR (excluding batteries).**

### A COPY OF YOUR SALES SLIP FOR PROOF OF PURCHASE IS REQUIRED

This warranty applies to the original purchaser for products which are installed in the United States or Canada and which are operated and maintained as intended for single family residential usage. This warranty is valid only with proof of purchase, shall commence on the date of purchase, and shall terminate (both as to original and any replacement products) on the anniversary date of the original purchase of the product stated on the above schedules.

This warranty covers defects in material and workmanship. This warranty **does not** cover parts which become defective as a result of negligence, misuse, use not in compliance with the Owner's Manual/Installation Instructions, accidental damage, improper handling, improper storage, improper installation, **lack of required routine maintenance** (as specified in the Owner's Manual/Installation Instructions), electrical damage, local gas impurities or failure to protect against combustibles. Product must be installed (and gas must be connected) as specified in the Owner's Manual/Installation Instructions by a **qualified professional installer**. Modifications to products which are not specifically authorized will void this warranty. Accessories, parts, valves, remotes, etc. when used must be Peterson products or this warranty is void. Warranted items will be repaired or replaced at Peterson's sole discretion. This warranty **does not** apply to rust, corrosion, oxidation, or discoloration unless the affected part becomes inoperable.

This warranty **does not** cover labor or labor related charges, except as provided by separate specific written programs from the Peterson Co. All repair work must be performed by a qualified professional service person and requires prior approval of Peterson.

Peterson may require the defective product or part to be returned to the factory to determine the cause of failure. Peterson will pay freight charges if the product or part is determined to be defective. This warranty does not cover breakage in shipment from our (Independent) distributor to its customer if the damage is determined to have occurred during that shipment.

This warranty specifically excludes liability for **indirect, incidental, or consequential** damages. Some states and provinces do not allow the exclusion or limitation of incidental or consequential damages, so the above exclusion may not apply to you. This warranty gives you specified legal rights, and you may have other rights that vary from state to state or province.

For additional information regarding this warranty, or to place a warranty claim, contact the R. H. Peterson dealer where the product was purchased.

When contacting your Peterson dealer or the R. H. Peterson Co., please provide the following information:

- Your name, address, telephone number, e-mail
- Sales receipt showing where purchased and date purchased
- Model number, serial number of product, date code
- Relevant information: installer, additions, repairs, when defect was first noted

**TO REGISTER YOUR PRODUCT ONLINE GO TO: WWW.RHPETERSON.COM,  
AND CLICK ON PRODUCT REGISTRATION. THANK YOU FOR YOUR PURCHASE.**

Quality Check		Date: _____	
Burner Orifices	Nat. _____	Leak Test:	_____ Model#: _____
Main:	_____	Burn Test:	_____ Serial#: _____
Other:	_____	Gas Type:	Nat. _____ Air Shutter: _____
			Inspector: _____