



ELECTRIC GRILL



RHP CONNECT APP Setup & Operation

GETTING STARTED

VERIFY COMPATIBILITY

The app and touch-controlled digital thermometer/thermostat is offered with select Fire Magic Electric Grills, and is compatible with select electronic devices. See Table 1 and Table 2.

Product	Models
Electric Grill	EL500

Table 1 - Appliance Compatibility

Electronic Device Operating System Requirements
iOS 11.0 or higher
Android v10.0 or higher

Table 2 - Electronic Device Requirements

INSTALL ELECTRIC GRILL

If not already done, follow the instruction manual provided with your electric grill for proper installation.

Then proceed to the following APP SETUP section.

DOWNLOAD AND INSTALL RHP CONNECT APP

Visit <https://www.firemagicgrills.com/digital-touch-control/>
or simply scan the QR code on the right.



Before setting up, ensure the RHP CONNECT app is downloaded and installed. Visit <https://www.firemagicgrills.com/digital-touch-control/> to download.

CREATE AN ACCOUNT

Note: This app setup process must be repeated for each device in the household that will be used for operation. To download and install the "RHP Connect" app, scan the QR code on the previous page, visit the link above, or search for "RHP Connect" in your app store (see Fig. 2-1 for app logo). Then follow the prompts on your screen to create an account. See Fig. 2-2 through Fig. 2-4 for details.

- You will receive an e-mail with a confirmation code; please check junk/spam folders in case the e-mail gets blocked.
- For select devices, you can sign in using external platforms such as Google or Facebook.



Fig. 2-1
Download RHP Connect

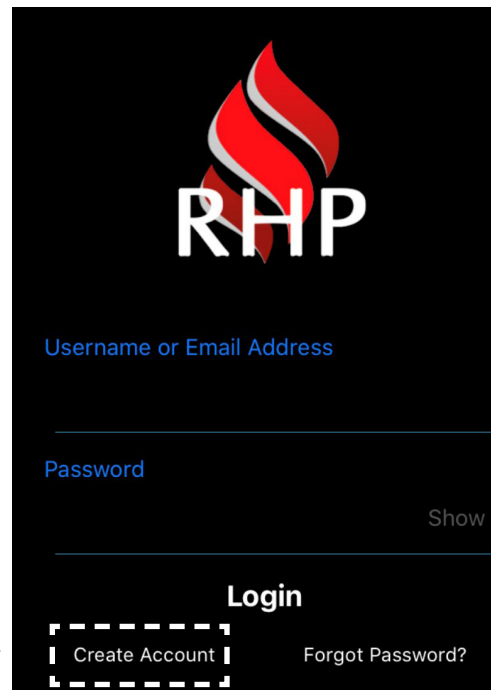

Fig. 2-2 Select create account / sign up

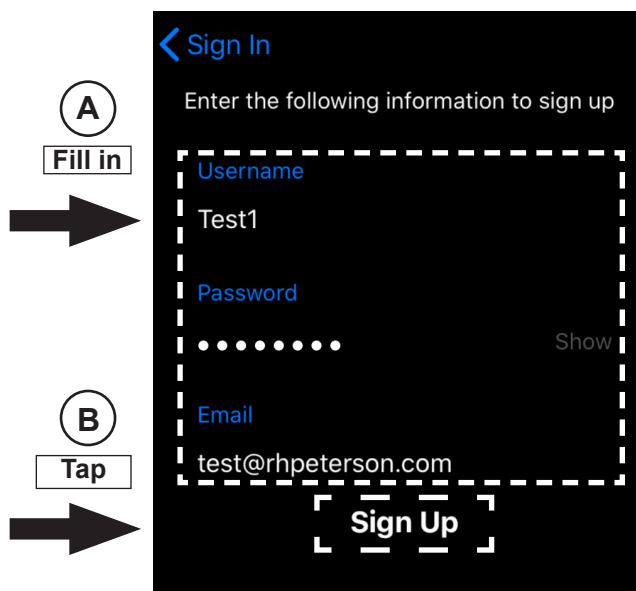

Fig. 2-3 Fill out screen and sign up

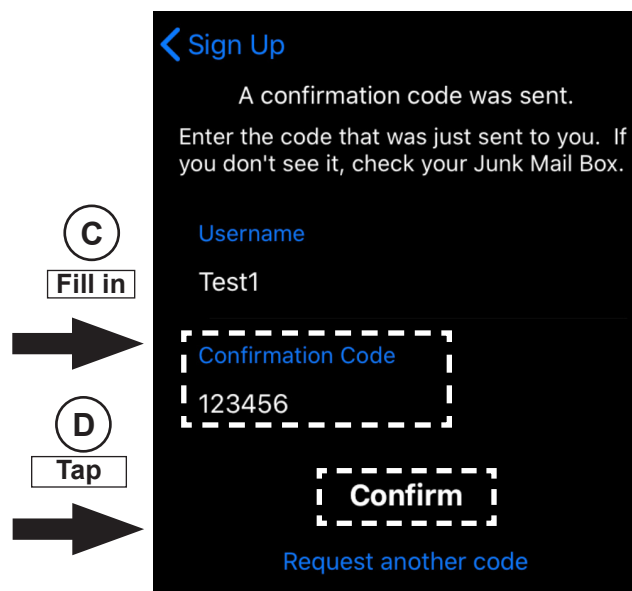

Fig. 2-4 Confirm sign up

APP SETUP (Cont.)

CREATE AN INITIAL ZONE

Once your account is created, proceed to the "Zones" screen, and if needed tap the ⊕ icon to enter the "New Zone" screen as shown below. Fill in the "Enter Location" field. The other fields will auto-fill. Then tap "Save Zone". Proceed by tapping on the newly created zone. See Fig. 3-1, Fig. 3-2 and Fig. 3-3 for details.

Note: It is recommended you allow RHP Connect to access your location for full functionality of the app.

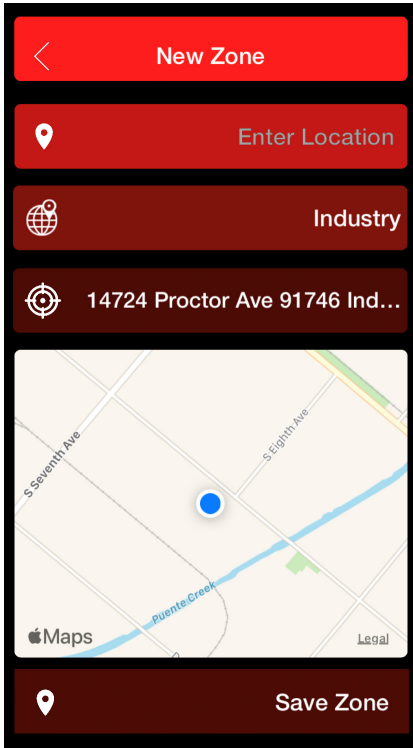

Fig. 3-1 Create zone

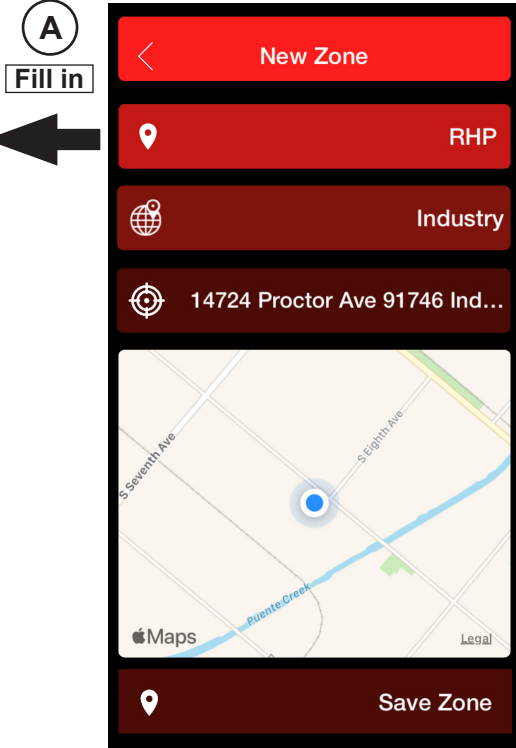

Fig. 3-2 Save zone

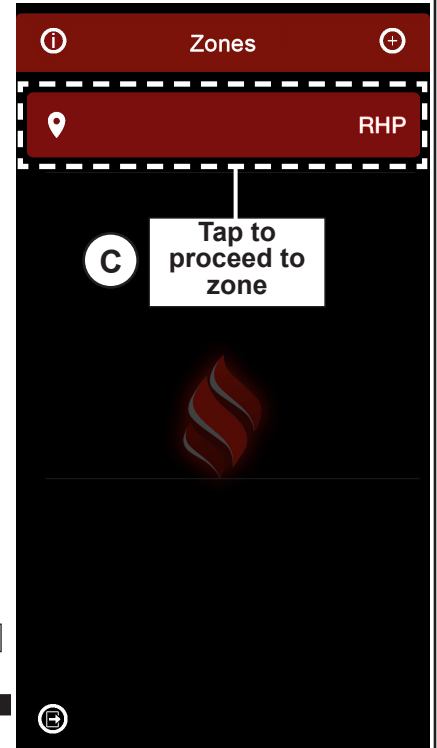

Fig. 3-3 Proceed to zone

APP SETUP (Cont.)

ADD YOUR DEVICE (SINGLE CONTROL MODELS)

1. Press the THERMOMETER POWER SWITCH on the grill control panel (see Fig. 4-1). The grill display will illuminate.
2. Hold your device up against the grill display screen (see Fig. 4-2), then follow the prompts to pair the grill to the app.
3. Fill in the fields as needed. Then tap "Connect". See Fig. 4-3, A and B, and Fig. 4-4, C.
4. Tap on your grill under the "Devices" screen (see Fig. 4-5, D, under SINGLE CONTROL MODELS). The app will proceed to the grill operating default screen.



Fig. 4-1 Turn on Unit



Fig. 4-2 Tap device against display

Your app is now ready to control the electric grill. Proceed to the APP OPERATING INSTRUCTIONS section.

ADD YOUR DEVICES (DUAL CONTROL MODELS)

1. Press the THERMOMETER POWER SWITCH on the grill control panel (see Fig. 4-1). Both grill displays will illuminate.
2. Hold your device up against the grill's LEFT display screen (see Fig. 4-2), then follow the prompts to pair the grill's left display to the app.
3. Fill in the fields as needed. Then tap "Connect". See Fig. 4-3, A and B, and Fig. 4-4, C.
4. Once the left side is paired, hold your electronic device up against the RIGHT grill screen display and tap the ⊕ icon (Fig. 4-5, D, under DUAL CONTROL MODELS). Repeat the pairing process for the right side. Both the left and right controls are now paired. They will display as one device as shown in Fig. 4-5, E.
5. Tap on your grill under the "Devices" screen (see Fig. 4-5, E). The app will proceed to the grill operating default screen.

Your app is now ready to control the electric grill. Proceed to the APP OPERATING INSTRUCTIONS section.

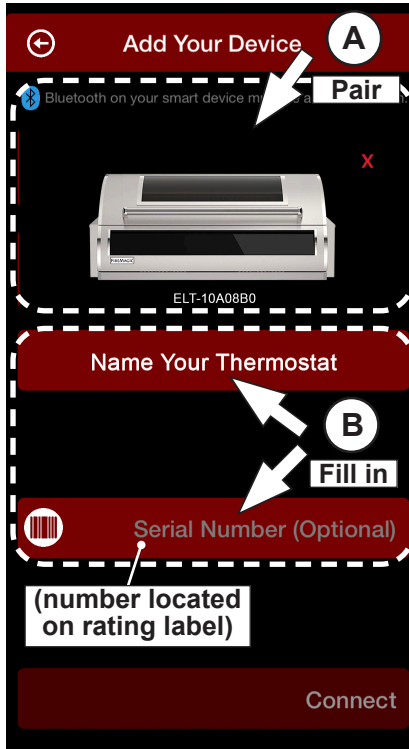

Fig. 4-3 Add your device

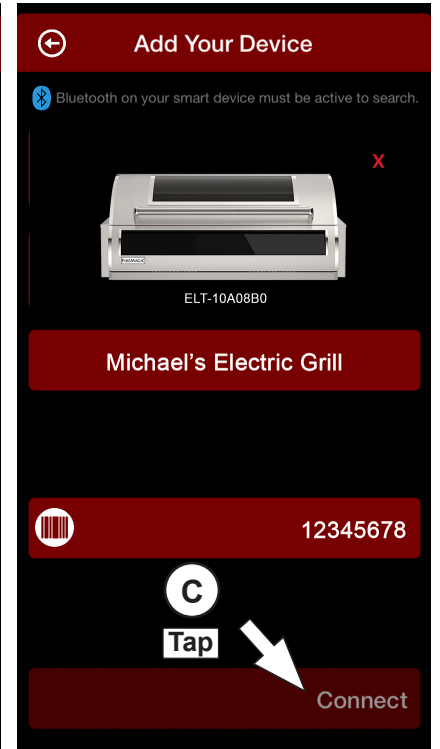

Fig. 4-4 Confirm connection

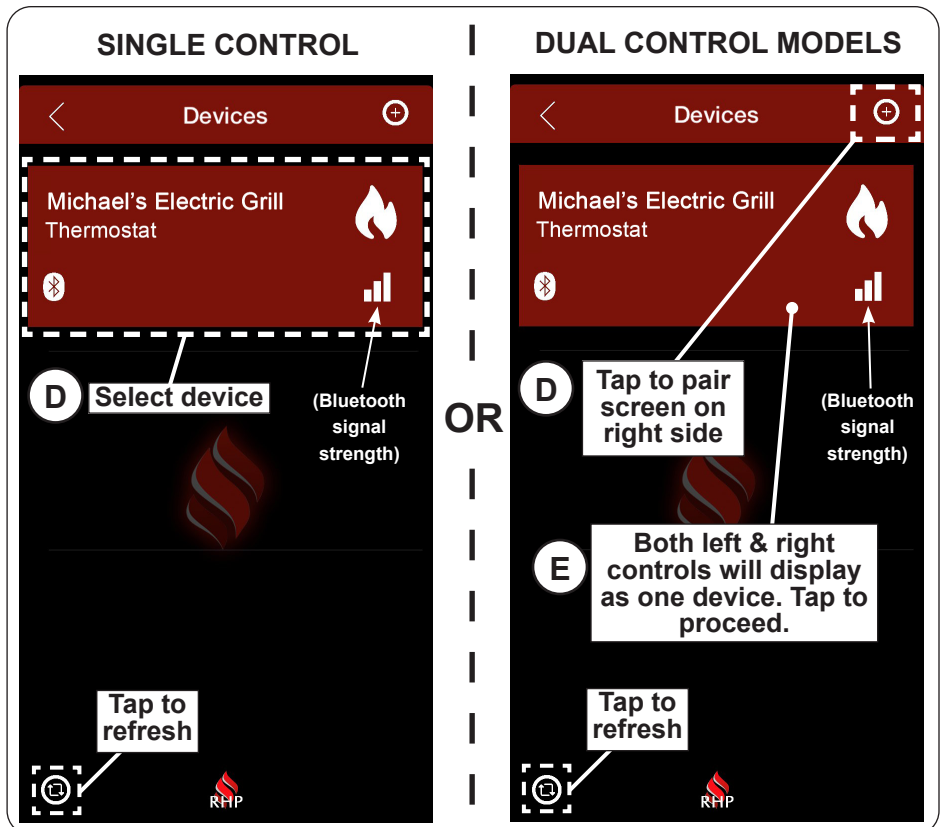

Fig. 4-5 Select device

OPERATING INSTRUCTIONS

BEFORE USE

Ensure that the electric grill is properly installed, the power source is turned on, the RHP connect app is setup on your electronic device, and your grill digital control(s) are successfully paired with the RHP CONNECT app.

Ensure that you have read all instructions completely and carefully prior to product use. Refer to them as needed.

Note: The digital controls on the grill are bluetooth and wifi enabled. Bluetooth has a max range operation of up to 30 feet (range may vary between device model/version). To extend the range of operation, the device can be connected to wifi. See the CONNECT TO WIFI section to setup.

Note: When using Bluetooth, the unit can be controlled by only one electronic device at a time, whereas connecting via wifi enables two devices to simultaneously operate the unit.

For best user experience and to update thermometer/thermostat firmware version, it is recommended to connect the thermometer/thermostat to wifi. See the CONNECT TO WIFI section for details.

FOR YOUR SAFETY, READ BEFORE USING THE GRILL

WARNING: IF YOU DO NOT FOLLOW THESE INSTRUCTIONS AND ALL INFORMATION FOUND IN THE SAFETY / WARNING CODES, AND IMPORTANT SAFEGUARDS SECTIONS OF THE ELECTRIC GRILL OWNER'S MANUAL, A FIRE MAY RESULT, CAUSING PROPERTY DAMAGE, PERSONAL INJURY, OR LOSS OF LIFE.

APP CONTROL MODES

Fire Magic Electric Grills are available with single and dual digital controls. **The app's single control mode is mainly depicted in this instruction.** Dual control models (grills with left and right digital controls) function identically to the single control mode, with the sole difference being that the dual mode is equipped with two controls that are controlled independently; the top control for the LEFT portion of the grill and the bottom control for the RIGHT portion of the grill. See below to familiarize yourself with the mode you will be using.

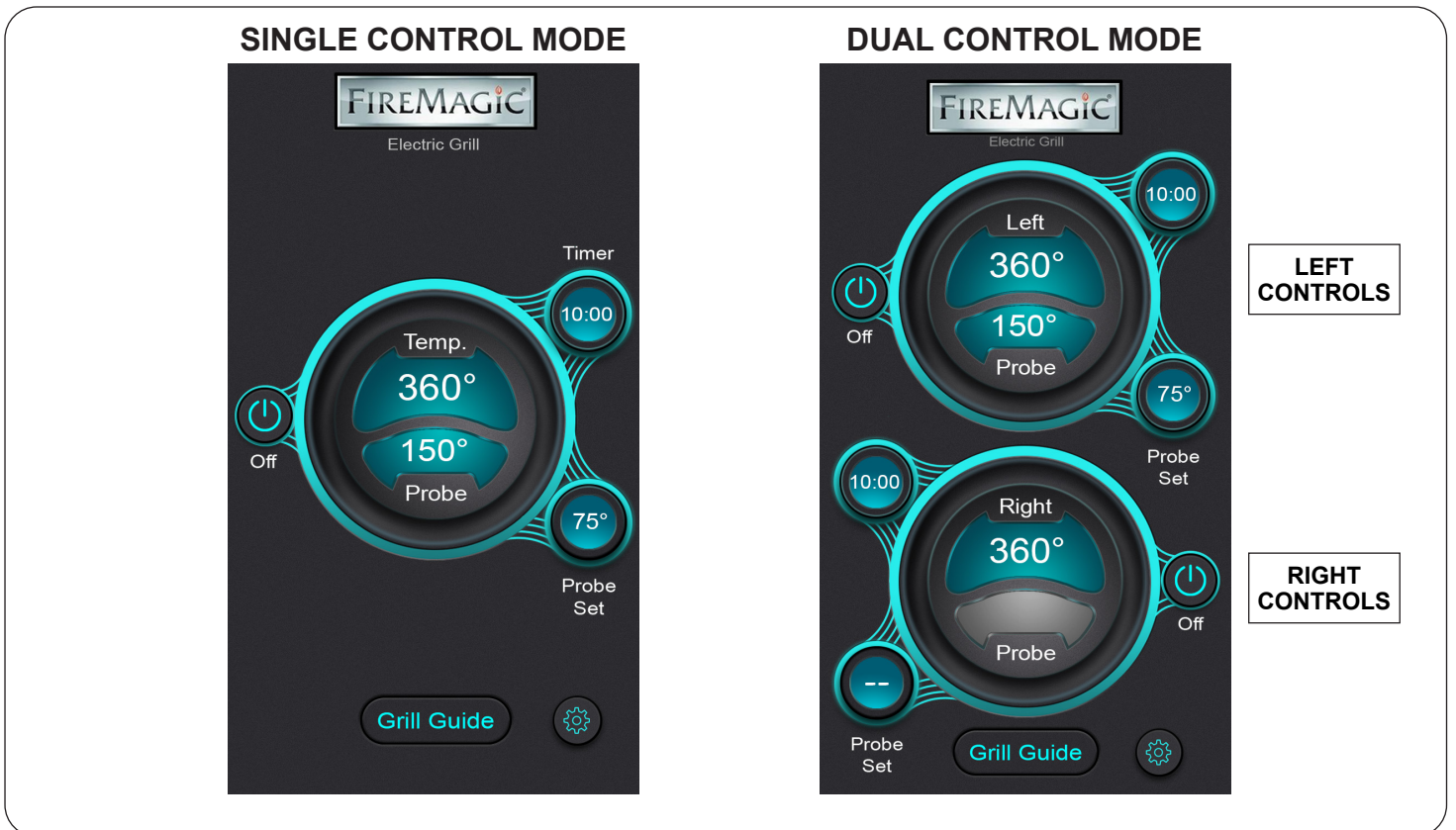

Fig. 5-1 Single and dual control modes

Operation continued on next page

INSTRUCTIONS D'UTILISATION

AVANT UTILISATION

Assurez-vous que le gril électrique est correctement installé, que la source d'alimentation est allumée, que l'application RHP Connect est configurée sur votre appareil électronique, et que les commandes numériques de votre gril sont connectées avec succès à l'application RHP Connect.

Assurez-vous d'avoir lu toutes les instructions attentivement et intégralement avant d'utiliser le produit. Référez-vous à elles au besoin.

Note: Les commandes numériques du gril sont équipées de la connectivité Bluetooth et Wi-Fi. Le Bluetooth a une portée maximale de fonctionnement pouvant atteindre 30 pieds (la portée peut varier en fonction du modèle/version de l'appareil). Pour étendre la portée de fonctionnement, l'appareil peut être connecté au Wi-Fi. Consultez la section "CONNECT TO WIFI" pour la configuration.

Note: Lors de l'utilisation du Bluetooth, l'unité ne peut être contrôlée que par un seul appareil électronique à la fois, tandis que la connexion via le Wi-Fi permet à deux appareils de fonctionner simultanément sur l'unité.

POUR VOTRE SÉCURITÉ, LIRE AVANT D'UTILISER LE GRIL

AVERTISSEMENT: SI VOUS NE SUIVEZ PAS CES INSTRUCTIONS, AINSI QUE TOUTES LES INFORMATIONS DANS LES SECTIONS DE SÉCURITÉ, AVERTISSEMENTS, ET MESURES DE SÉCURITÉ IMPORTANTES DU MANUEL DU PROPRIÉTAIRE DU GRIL ÉLECTRIQUE, UN INCENDIE PEUT SURVENIR, CAUSANT DES DOMMAGES MATÉRIELS, DES BLESSURES PERSONNELLES OU LA PERTE DE VIES.

Pour des détails complets sur les commandes numériques du gril électrique, consultez le manuel du propriétaire du gril électrique.

ALLUMAGE DU GRIL ET DES COMMANDES NUMÉRIQUES

Pour contrôler le gril électrique via l'application, vous devez d'abord l'allumer **manuellement**. L'interrupteur d'alimentation du thermomètre du gril se trouve sur le côté droit du panneau de contrôle.

1. Appuyez sur l'**interrupteur d'alimentation du thermomètre** (voir Fig. 6-1). L'affichage s'allumera et restera en mode "veille".
2. Appuyez et maintenez enfoncé le bouton de la **MINUTERIE** (sur l'affichage du gril) jusqu'à ce que le reste de l'affichage s'illumine. Voir Fig. 6-2, A. Cela active le thermomètre/thermostat.
3. Maintenant que le thermomètre/thermostat est allumé, **LES ÉLÉMENTS CHAUFFANTS COMMENCERONT À PRÉCHAUFFER** et les lectures du gril s'afficheront sur l'application. Voir Fig. 6-2, B et Fig. 6-3.

AVERTISSEMENT: L'état de marche/arrêt de l'élément chauffant doit être vérifié en personne, car c'est un appareil surveillé. Le **point** à côté de la lecture de la température **sur le gril** (voir Fig. 6-2) indique que l'élément est allumé.

- L'unité commence automatiquement à préchauffer à la température par défaut de 450°F (232°C). Pour régler la température souhaitée, consultez la section RÉGLAGE DE LA TEMPÉRATURE DE CUISSON ci-dessous.

4. **Pour les modèles à double commande**, répétez l'étape 2 pour activer l'autre thermomètre/thermostat.

RÉGLAGE DE LA TEMPÉRATURE DE CUISSON

Réglez la température de cuisson en tapant sur l'affichage de la **Temp**. Entrez la température souhaitée, puis appuyez sur **Done**.

- L'affichage de la température va augmenter jusqu'à ce qu'elle atteigne la température définie. Une fois atteinte, une notification s'affichera à l'écran, l'appareil vibrera et sonnera. Suivez les instructions à l'écran pour le mettre en silence.
- La température de consigne affichée reste inchangée quelle que soit la température réelle. Même en cas d'ouverture fréquente du couvercle, de conditions environnementales changeantes ou d'ajout d'aliments froids provoquant des fluctuations de température, la température de consigne restera la température cible jusqu'à ce que vous en régliez une nouvelle manuellement ou si elle diffère de 100°F par rapport à la température ambiante réelle.

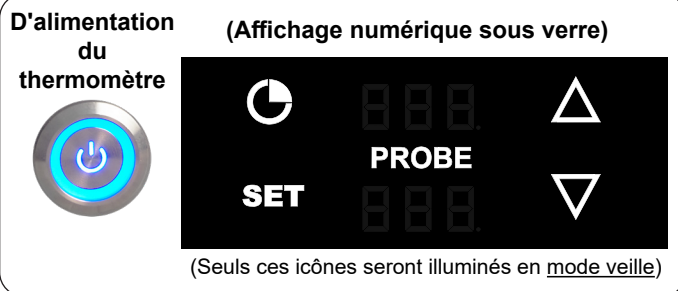

Fig. 6-1 Allumer le gril électrique

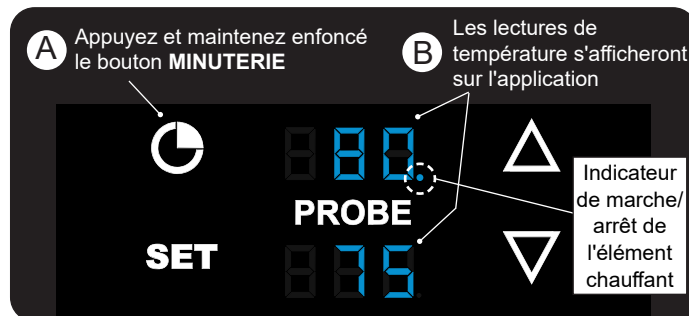

Fig. 6-2 Allumer le thermomètre/thermostat



Fig. 6-3 Températures affichées sur l'application

OPERATING INSTRUCTIONS (cont.)

For complete details regarding the digital controls featured on the electric grill, see the electric grill owner's manual.

POWER ON GRILL AND DIGITAL CONTROLS

To control the electric grill via the app, the grill must first be **manually** turned on. The grill thermometer power switch is located on the right side of the control panel.

1. Press the **thermometer power switch** (see Fig. 7-1). The display will turn on and remain in "standby mode".
2. Press and hold the **TIMER** button (on the grill display) until the remainder of the display illuminates. See Fig. 7-2, A. This activates the thermometer/thermostat.
3. Now that the thermometer/thermostat is turned on, **THE HEATING ELEMENTS WILL START TO PREHEAT** and the grill readings will display on the app. See Fig. 7-2, B and Fig. 7-3.

WARNING: The heating element ON/OFF status must be verified in person - it is an attended appliance. The **dot** next the temp. reading on the grill (see Fig. 7-2) indicates that the element is on.

- The unit automatically begins to preheat to the default temperature of 450° F. To set your desired temperature, see the SET GRILLING TEMPERATURE section below.
 - The readings on the app update every 5 seconds.
4. For dual control models, repeat step 2 to activate the other thermometer/thermostat.

POWER OFF GRILL DIGITAL CONTROLS

Press the **Off** button on the app to turn off the heat and thermometer/thermostat (see Fig. 7-3). The controls will remain inactive and the display will switch to "standby mode", and the heating element will turn off (see Fig. 7-1).

The thermometer power button on the grill's control panel **MUST** be switched to the OFF position when the grill is not in use.

Note: The Off button on the app WILL NOT turn ON power to the thermometer/thermostat. It must be manually turned on via the grill by pressing and holding the TIMER button. See the section above and Fig. 7-1 to turn on.

SET GRILLING TEMPERATURE

Set the grilling temperature by tapping on the **Temp** display reading. Input in the desired temperature, then tap **Done**.

- The temp. display will climb until it reaches the set temperature. Once reached, a notification will display on the screen, the device will vibrate and ring. Follow the prompts on the screen to silence.
- The displayed set temperature remains unchanged regardless of the actual temperature. Even with frequent lid opening, varying environmental conditions, or the addition of cold food causing temperature fluctuations, the set temperature will remain as the target temperature until you manually set a new one or if there's a 100°F difference between the set temperature and the actual ambient temperature.

Thermometer power switch



(Under glass digital display)

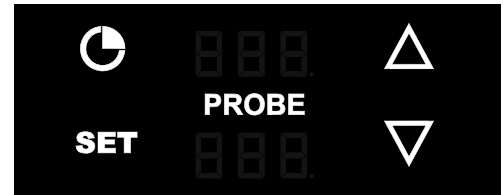

(Only these icons will be illuminated when in standby mode)

Fig. 7-1 Turn on electric grill

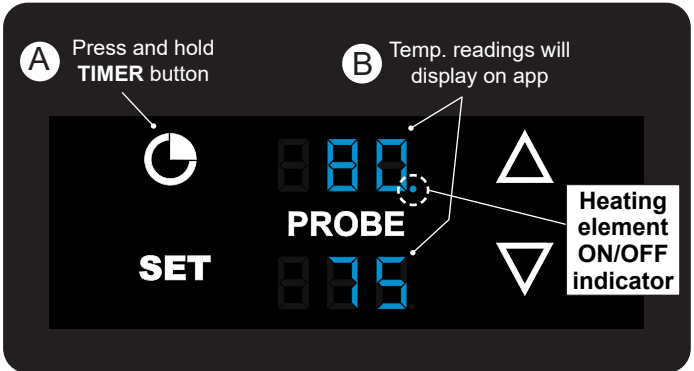

Fig. 7-2 Power ON thermometer/thermostat



Fig. 7-3 Temp readings on app

OPERATING INSTRUCTIONS (cont.)

SETTING THE TIMER

Set the timer by tapping on the **Timer** display. Input the desired time, then tap **OK** (see Fig. 8-1).

- The timer will start and the count down will show on the Timer display.
- The timer displays in the format of Minutes:Seconds (00:00). See Fig. 8-1.
- Once the timer reaches zero, a notification will display on the screen, the device will vibrate and ring (if set on your device), and the grill controls will start flashing and the alarm will sound. Follow the prompts on the screen to silence.
- The timer can be set at a maximum of two hours.

MEAT PROBE

Note: The probe display grays-out when the meat probe is not connected (see Fig. 8-1).

For single control models, the probe jack is on the right side of the control panel. For dual control models, a probe jack can be found on the left and right sides of the control panel.

Connect the meat probe to the probe jack. The probe temperature will display. At this point, the meat probe can be inserted into the meat for temperature monitoring.

For complete details about your meat probe, see the electric grill owner's manual under the DIGITAL THERMOMETER / THERMOSTAT section.

To set the meat probe temp/alarm:

Tap on the **Probe Set** display and input your desired temperature (see Fig. 8-2). Tap **Done** to confirm. The target temp will be shown on the probe set display.

- The probe is calibrated specifically for use at temperatures between 125°F and 180°F. Do not set the probe outside of those parameters.



Fig. 8-1 Tap timer to set



Fig. 8-2 Tap probe set to set probe temp

OPERATING INSTRUCTIONS (cont.)

GRILL GUIDE

The grill guide serves as a convenient point of reference during cooking, and when the meat probe is connected, you may choose a temperature from the grill guide and it will set it to the meat probe temp/alarm.

1. From the default screen, tap on **Grill Guide**.
2. Tap on the desired temperature, then tap **OK** to confirm. See Fig. 9-1.

Note: Dual control models - When making your selection, a prompt will ask to apply your selection to the left or right control. Select **Left Probe** or **Right Probe** and the prompt will close and apply your settings automatically.

CONNECT TO WIFI

Connecting the app to a wifi network (2.4 GHz only) will extend the range for a better grilling experience. Before setting up wifi, ensure your electronic device is already connected to the wifi network.

Important: Ensure your electric grill is within range of the wifi signal.

1. From the default screen, tap on the **Settings** icon.
2. Verify the wifi name displaying in the app is correct.
3. Type in the wifi password. If needed, clear out the dots before typing in the password.
4. Tap **OK**. It will exit the settings screen and go back to the default screen. A prompt reading "WiFi Setup Successful" will display. See Fig. 9-2.

Note: It is possible that the thermometer on the grill may reboot after successfully connecting to wifi.

Note: If the *incorrect* wifi name is displayed, tap on the incorrect wifi name and select the correct wifi name from the list of available networks, input the password, then tap **OK**.



Fig. 9-1 Grill guide

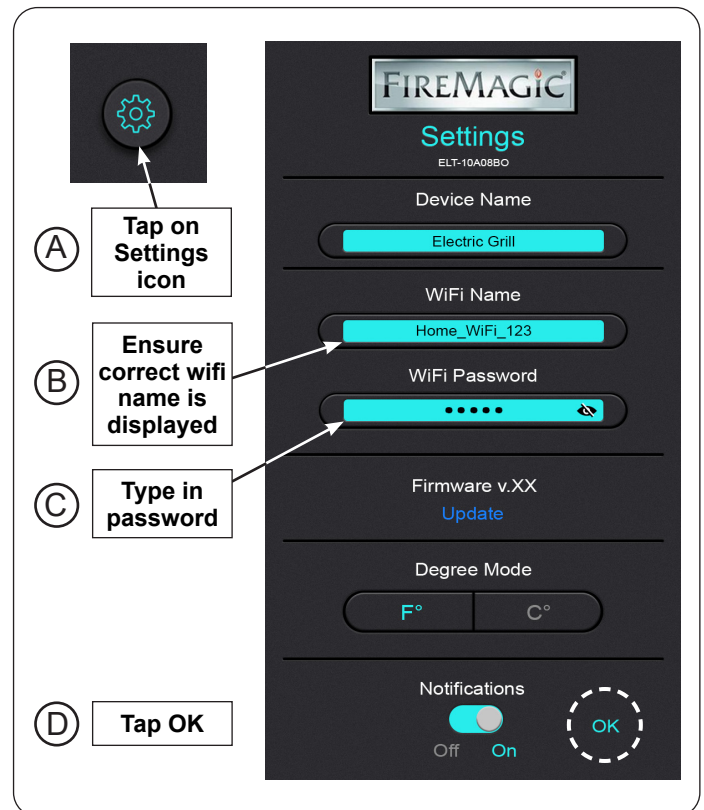

Fig. 9-2 Wifi setup

OPERATING INSTRUCTIONS (cont.)

CHANGE DEGREE MODE (F°/C°)

1. From the default screen, tap on the **Settings** icon.
2. Under Degree Mode, select **F°** or **C°**, then tap **OK** to confirm. See Fig. 10-1.

NOTIFICATIONS

1. From the default screen, tap on the **Settings** icon.
2. Tap on the Notifications toggle switch to turn notifications **on** or **off**, then tap **OK** to confirm. See Fig. 10-1.

Note: Notifications may vary between device models and/or notification settings on the device's operating system.

Note: If solely operating via bluetooth, the screen on the electronic device must remain on (disable screen timeout settings on device) at all times while cooking to receive all notifications.

DUAL CONTROL SWAP

If the app's left and right controls are reversed:

1. From the default screen, tap on the **Settings** icon.
2. Under Device ID, tap on **<-Swap->** to swap the controls, then tap **OK** to confirm. See Fig. 10-2.

FIRMWARE UPDATE

1. Ensure:
 - the thermometer power switch on the grill is turned on (leave unit in "standby mode" - heat is off)
 - the electric grill is connected to the app
 - the app and appliance is connected to wifi (must be connected to wifi for update to work, see **CONNECT TO WIFI** section to setup)
 - the grill and electronic device have a strong wifi signal
2. Once all the above are confirmed, from the default screen tap on the Settings icon.
3. Under Firmware, tap on "Update".

Note: If "update" button is not visible, the firmware version is up to date or wifi is not connected.

ADDITIONAL SETTINGS

- The device ID number is for tech support reference.
- To rename your device name, tap on the device name, type in new name, then tap **Done**.

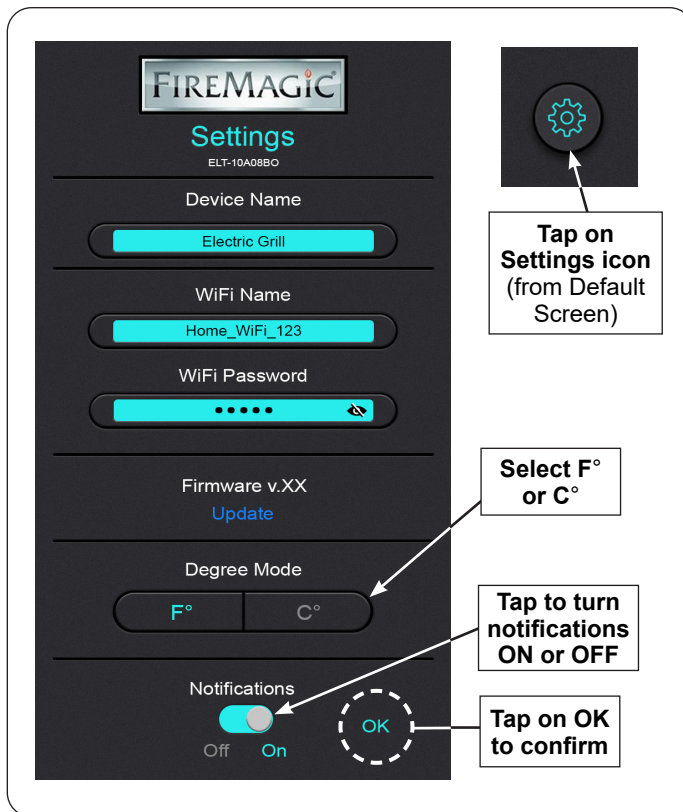

Fig. 10-1 Degree Mode & Notifications

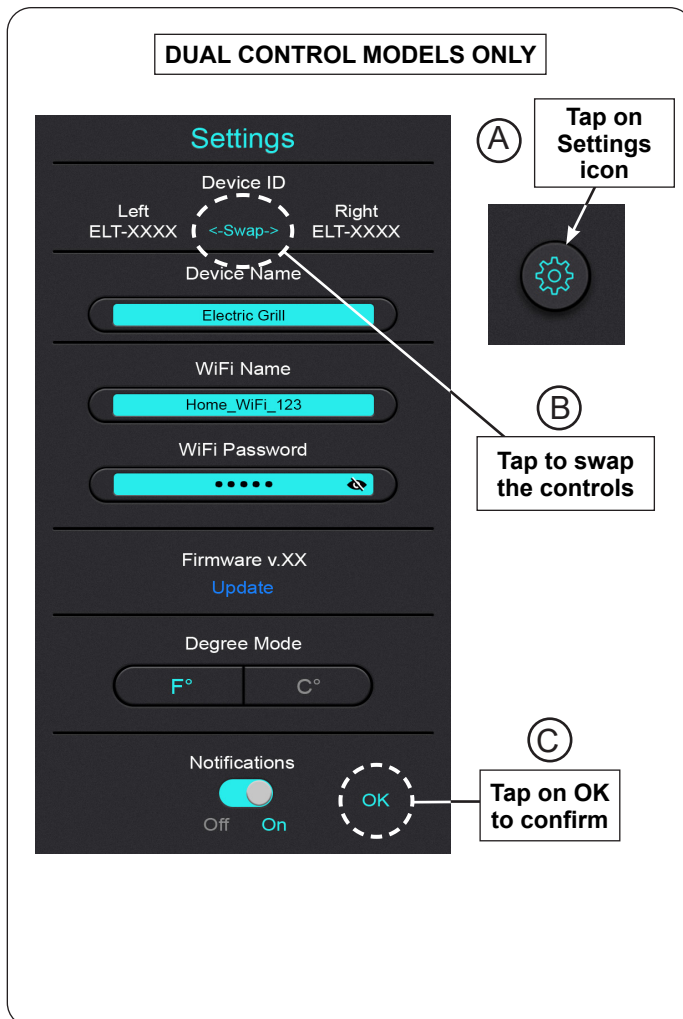

Fig. 10-2 Swap dual controls

OPERATING INSTRUCTIONS (Cont.)

ADDING, EDITING, DELETING A NEW ZONE OR DEVICE

- To add a new zone or device, tap the ⊕ icon found on the top right of your screen (see Fig. 11-1 or Fig. 11-2).
- To delete a zone or device, slide your finger across the desired unit, and tap "Delete" (see Fig. 11-1 or Fig. 11-2).
- To edit an existing zone, slide your finger across the desired zone, and tap "Edit" (see Fig. 11-1).

LOGGING OUT

To log out, simply click on the **Logout** icon and then tap **Yes** (see Fig. 11-3). To prevent unwanted use, it is recommended to log out after device is turned off.



Fig. 11-1 Add/Edit/Delete Zone

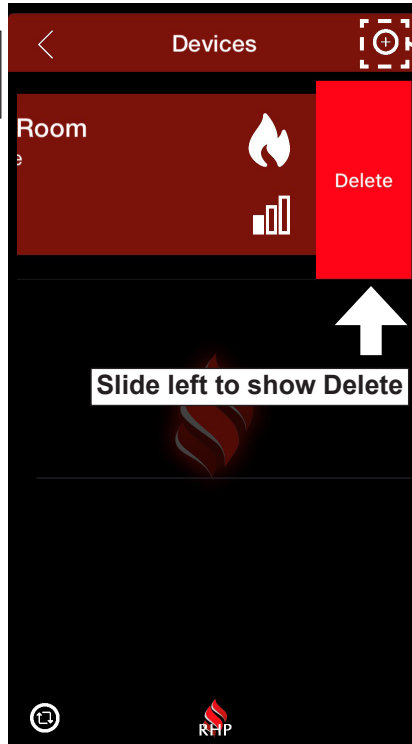

Fig. 11-2 Add/Delete Device

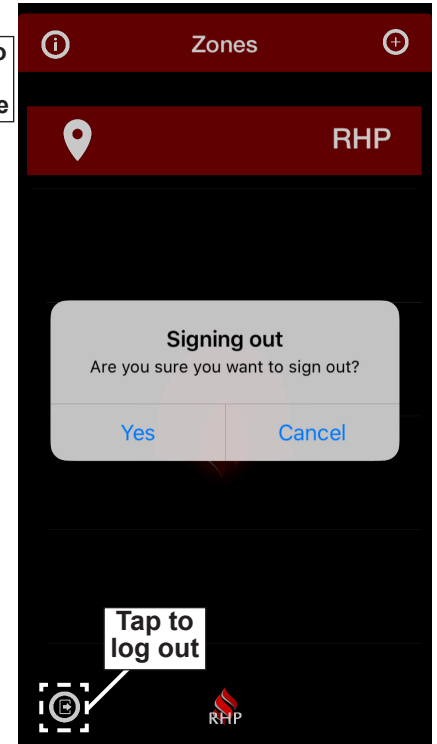

Fig. 11-3 Logging out

FORGOT PASSWORD

Select "**Forgot password**" on the home screen. Then follow the prompts on your screen to update your password. See Fig. 11-2 through Fig. 11-4 for details.

- You will receive an e-mail with a confirmation code; please check junk/spam folders in case the e-mail gets blocked.

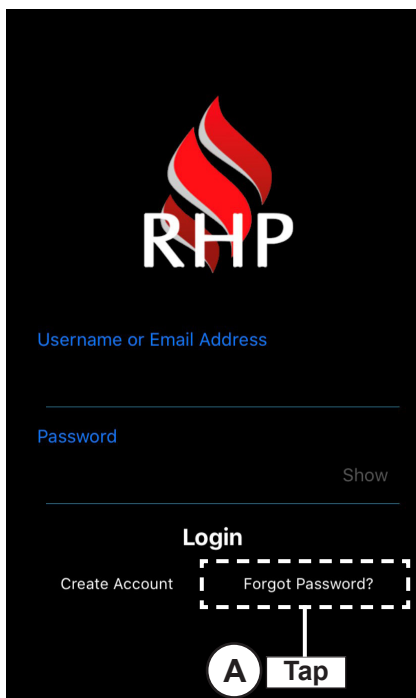

Fig. 11-2 Select forgot password

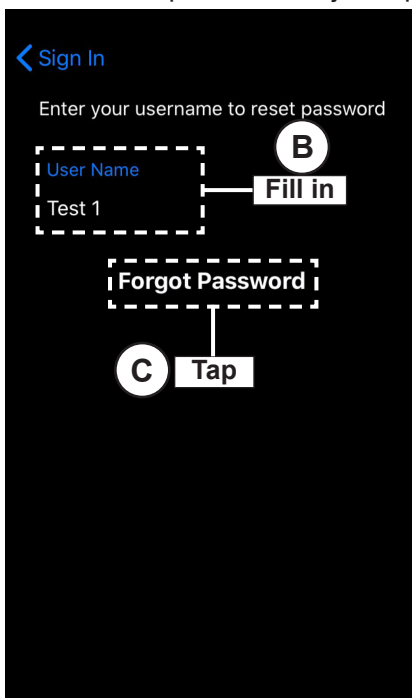

Fig. 11-3 Fill out screen

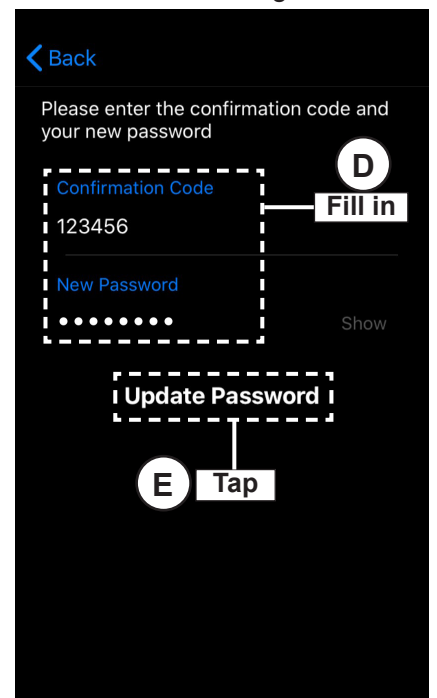

Fig. 11-4 Update password

TROUBLESHOOTING

If you are having trouble while using the app, see below to identify the problem.

PROBLEM	POSSIBLE CAUSE	CORRECTION
Digital display does not work	<ol style="list-style-type: none"> 1. Thermometer power switch not on 2. Electronic device out of range of electric grill 3. App not paired with electric grill 4. Faulty thermometer/thermostat control 5. Power failure 6. Power not connected properly 	<ol style="list-style-type: none"> 1. Ensure thermometer power switch on control panel is on (and light is illuminated). 2. Ensure device is within 30 feet (bluetooth) or within the wifi signal range. 3. Pair device. Refer to the ADD YOUR DEVICE section for details. 4. Check/replace thermometer/thermostat control. 5. Check if power is available. 6. Make sure the power source and powering equipment is properly connected and tested.
Digital display does not respond to electronic device	<ol style="list-style-type: none"> 1. App not paired with electric grill 2. App update needed 3. Thermometer/thermostat firmware update needed 4. Electronic device out of range of electric grill 5. Bluetooth or wifi disconnected 6. Unable to use the app 7. Faulty thermometer/thermostat control 	<ol style="list-style-type: none"> 1. Pair device. Refer to ADD YOUR DEVICE section for details. 2. Check in the app store for any updates and follow the prompts. 3. Update firmware via the app. Refer to the FIRMWARE UPDATE section for details. 4. Ensure device is within 30 feet (bluetooth) or within the wifi signal range (if setup to wifi). 5. Reconnect bluetooth or wifi on your electronic device. 6. If you are unable to operate the grill using the app, turn off the grill by pressing the thermometer power switch or you may continue to operate the electric grill manually using the grill's touch controls. Reinstall the app or call support. 7. Check/replace thermometer/thermostat control.
Error code: Err	<ol style="list-style-type: none"> 1. Thermocouple failure 	<ol style="list-style-type: none"> 1. Thermocouple disconnected or faulty. Check connection or replace if faulty.

TECHNICAL APP ISSUES

If you need assistance on a technical issue related to the app (log in, connectivity, etc.), please e-mail the app support department support@app-assist.com or call (833) 437-8783. You may also tap on the support icon from the Zones screen (see Fig. 12-1) to call support directly from the app.

ELECTRIC GRILL ISSUES

If you are having trouble with the operation of the electric grill, see the TROUBLESHOOTING section of the manual included with your grill.

If the information on this page does not resolve your issue, please contact your local dealer, e-mail our general support department: support@rhpeterson.com, or visit our web site at www.rhpeterson.com.

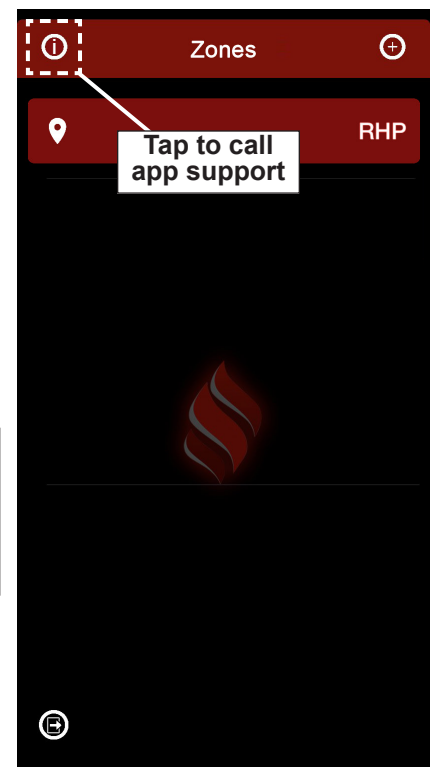

Fig. 12-1 Call support

NOTES

Please use this page to record any information that you may want to have at hand.