

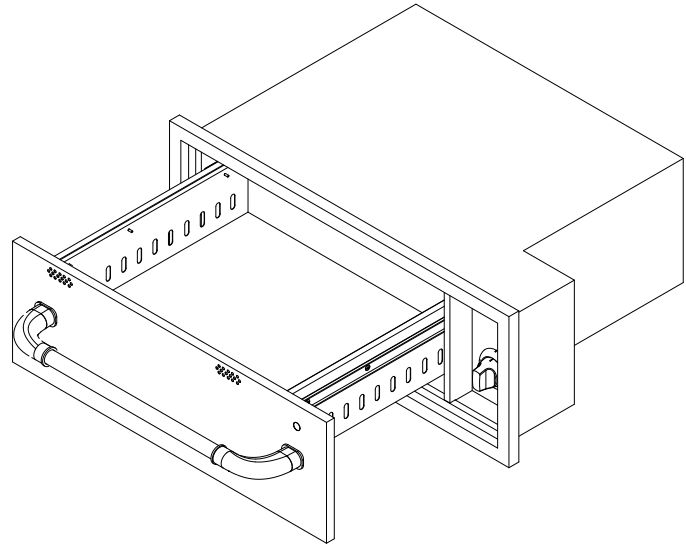

WARMING DRAWER

SPEC SHEET



ISOMETRIC VIEW

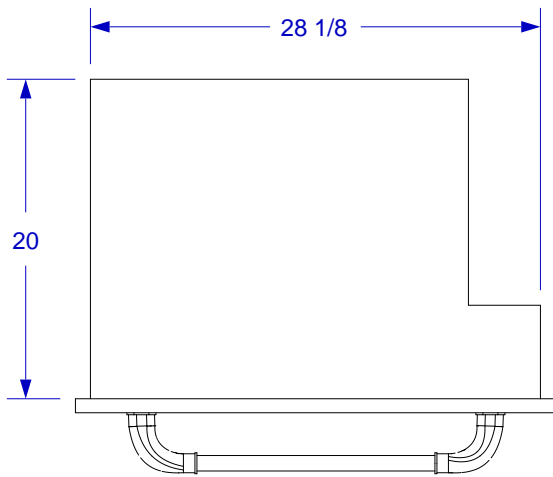

TOP VIEW

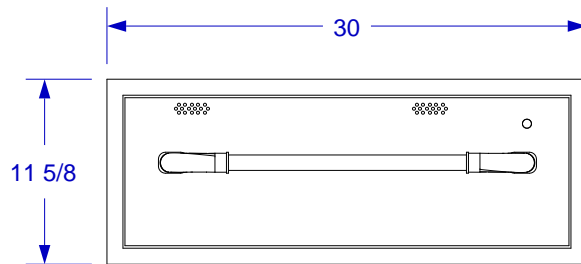

FRONT VIEW

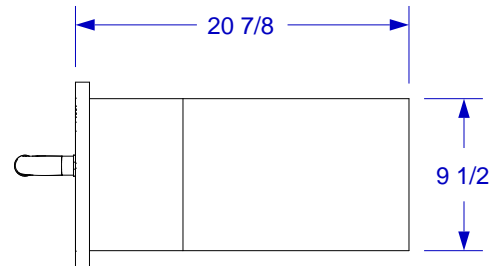

RIGHT SIDE VIEW

NOTES:

1. CUTOUT DIMENSIONS: 28 1/2" W X 10" L X 20 1/4" D
2. SCALE: 1" = 1'-0"
3. REVISION: 10/2009