

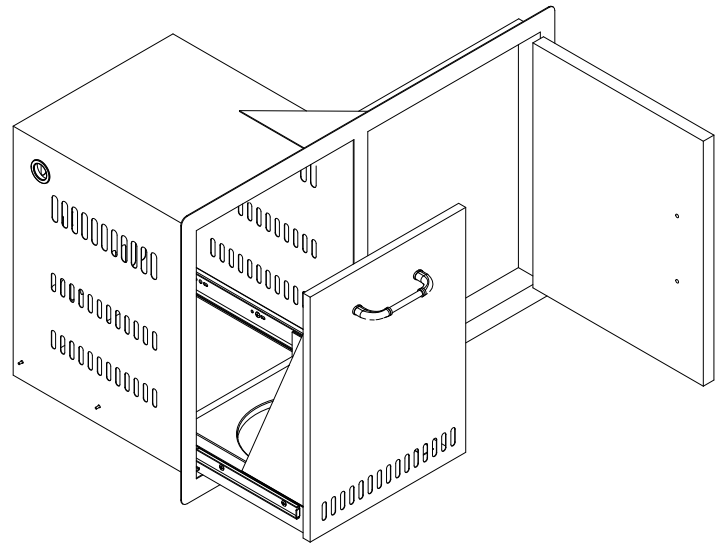

DOOR/PROPANE DRAWER COMBO SPEC SHEET

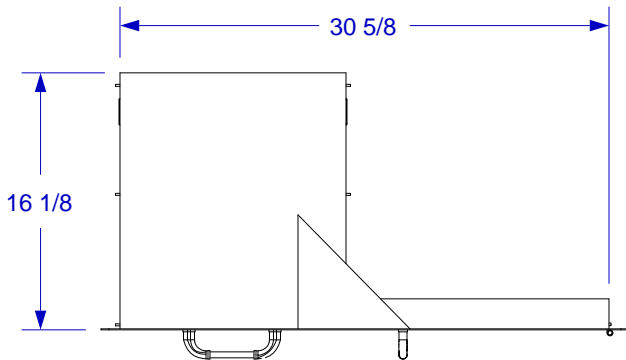

ISOMETRIC VIEW



TOP VIEW

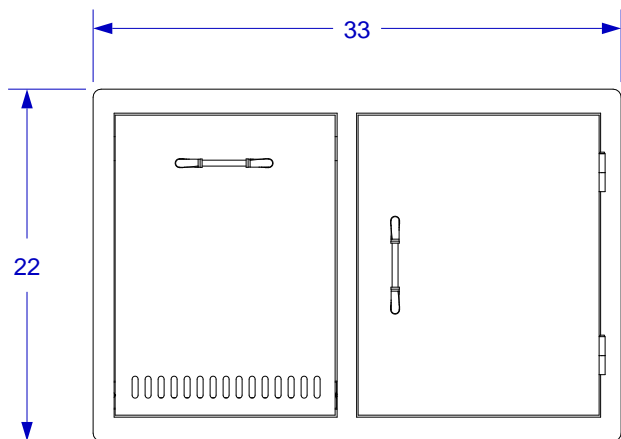

FRONT VIEW

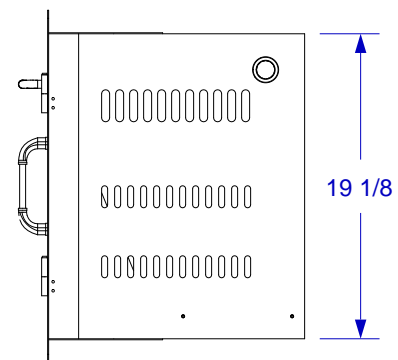

RIGHT SIDE VIEW

NOTES:

1. CUTOUT DIMENSIONS: 31"W X 19 1/2"L X 16 3/8"D
2. SCALE: 1" = 1'-0"
3. REVISION: 10/2009