

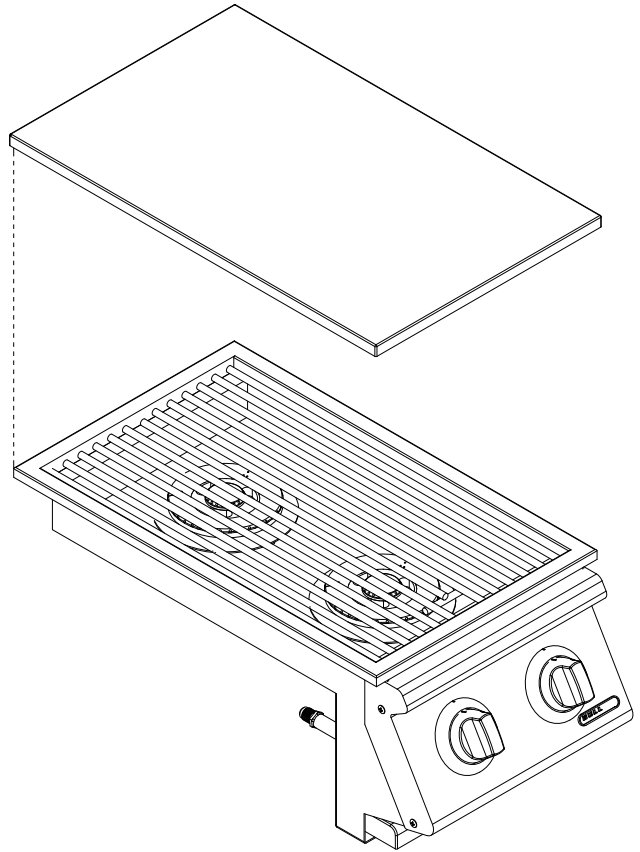

SLIDE-IN DOUBLE SIDEBURNER SPEC SHEET

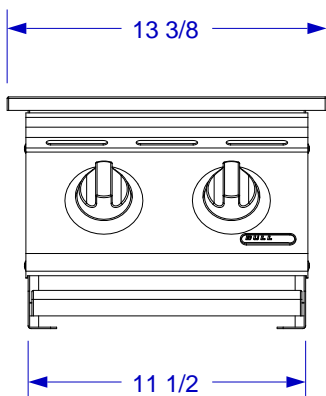

ISOMETRIC VIEW



FRONT VIEW

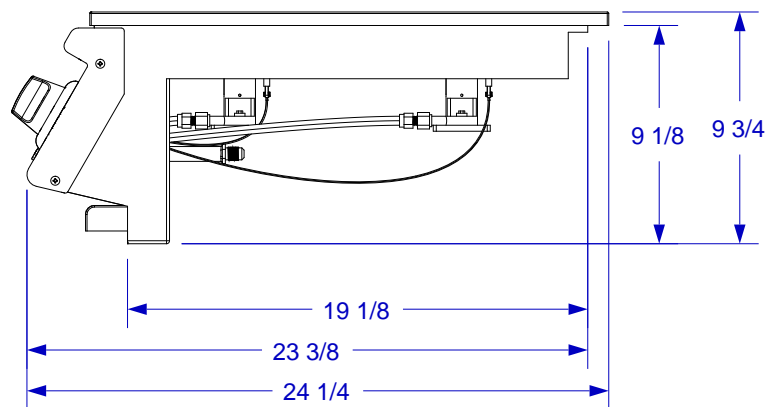

RIGHT SIDE VIEW

NOTES:

1. CUTOUT DIMENSIONS: 12 1/8"W X 20 3/4"L X 10"D
2. SCALE: 1 1/2" = 1'-0"
3. REVISION: 11/2011